

SHIP PRODUCTION COMMITTEE  
FACILITIES AND ENVIRONMENTAL EFFECTS  
SURFACE PREPARATION AND COATINGS  
DESIGN/PRODUCTION INTEGRATION  
HUMAN RESOURCE INNOVATION  
MARINE INDUSTRY STANDARDS  
WELDING  
INDUSTRIAL ENGINEERING  
EDUCATION AND TRAINING

May 18, 1998  
NSRP 0516  
N1-93-3

# **THE NATIONAL SHIPBUILDING RESEARCH PROGRAM**

## **Waste Water Treatment Technology Survey**

U.S. DEPARTMENT OF THE NAVY  
CARDEROCK DIVISION,  
NAVAL SURFACE WARFARE CENTER

in cooperation with  
National Steel and Shipbuilding Company  
San Diego, California

## DISCLAIMER

These reports were prepared as an account of government-sponsored work. Neither the United States, nor the United States Navy, nor any person acting on behalf of the United States Navy (A) makes any warranty or representation, expressed or implied, with respect to the accuracy, completeness or usefulness of the information contained in this report/manual, or that the use of any information, apparatus, method, or process disclosed in this report may not infringe privately owned rights; or (B) assumes any liabilities with respect to the use of or for damages resulting from the use of any information, apparatus, method, or process disclosed in the report. As used in the above, "Persons acting on behalf of the United States Navy" includes any employee, contractor, or subcontractor to the contractor of the United States Navy to the extent that such employee, contractor, or subcontractor to the contractor prepares, handles, or distributes, or provides access to any information pursuant to his employment or contract or subcontract to the contractor with the United States Navy. ANY POSSIBLE IMPLIED WARRANTIES OF MERCHANTABILITY AND/OR FITNESS FOR PURPOSE ARE SPECIFICALLY DISCLAIMED.

# WASTE WATER TREATMENT TECHNOLOGY SURVEY

Submitted to:

**National Steel and Shipbuilding Co.  
Harbor Drive and 28th St.  
San Diego, CA 92138**

**January 15, 1998**

by:

**Bath Iron Works  
700 Washington Street  
Bath, ME 04530**

and

**The University of Michigan  
Transportation Research Institute  
Marine Systems Division  
2901 Baxter Road  
Ann Arbor, MI 48109-2150**

Principal Investigators:

**Albert W. Horsmon, Jr.  
Scott B. Clapham  
The University of Michigan**

Technical Report Documentation Page

1. Report No.		2. Government Accession No.		3. Recipient's Catalog No.	
4. Title and Subtitle  Waste Water Treatment Technology Survey				5. Report Date January 15, 1998	
				6. Performing Organization Code	
7. Author(s) The Marine Systems Division				8. Performing Organization Report No. UMTRI-97-48	
9. Performing Organization Name and Address The University of Michigan Transportation Research Institute 2901 Baxter Road, Ann Arbor, MI 48109-2150				10. Work Unit No. (TRAIS)	
				11. Contract or Grant No. A-0926-H91	
12. Sponsoring Agency Name and Address Bath Iron Works 700 Washington Street Bath, ME 04530				13. Type of Report and Period Covered  Technical	
				14. Sponsoring Agency Code	
15. Supplementary Notes					
16. Abstract  <p>The objective of this project was to investigate methods for treating the ballast water from naval vessels that have compensated fuel tanks. For a repair availability, these tanks must be emptied, cleaned and gas freed before they can be worked on. This process needs to be performed quickly to avoid delays and associated costs in the yard. The goal was to identify treatment technologies that could process the ballast water at 500 gpm and clean it sufficiently to discharge it back into the local navigable waters. There are about 100 vessels in the group of ships with compensated fuel tanks. With an oil and water interface, there is some mixing of fuel and water so that free oil and emulsified oil are part of the ballast water. The free oil can be separated from the water more easily than the emulsified oil. Testing of the ballast water turned up different amounts of emulsified oil, which, at less than 10 ppm, can still leave a sheen on the water.</p> <p>A number of treatment solutions were studied with a combination of coalescing tanks or specialized high speed centrifuges, along with dissolved or infused air flotation, surfacing as the best treatment methods for a 500 gpm system. Use of a storage system to hold the water until processed by a slower system was also studied. Cost benefit and sensitivity analyses are presented. In the final analysis, there are a number of options to choose from for a shipyard facing this problem. Tools are provided for a yard to perform its own analysis.</p>					
17. Key Words  waste water, water treatment, ballast water, compensated fuel tanks			18. Distribution Statement		
19. Security Classif. (of this report) Unclassified		20. Security Classif. (of this page) Unclassified		21. No. of Pages 54	22. Price

## EXECUTIVE SUMMARY

---

The objective of the Waste Water Treatment Technology Survey was to investigate treatment methods that could quickly treat the ballast water from naval vessels that have compensated fuel tank arrangements. When these vessels enter a shipyard for a repair availability, the tanks must be emptied, cleaned and gas freed before they can be worked on. This process is frequently on the critical path and, if not performed quickly, either delays vessel completion or requires expensive overtime labor expenditures to make up the time. The basic goal of the project was to identify treatment technologies that could process the ballast water at 500 gpm and clean it sufficiently to discharge it back into the local navigable waters. This is the Phase II Final Report which incorporates the Phase I Report on a literature survey, shipyard and industry surveys of treatment options.

Vessels equipped with compensated fuel tanks have piping arrangements that automatically allow ballast water to flow into the fuel tanks as the fuel is consumed so that the vessels maintain a constant draft. These vessels include the DDG-51, ARLEIGH BURKE class, the CG-47, TICONDEROGA class, the four DDG-963 KIDD class, and the DD-963 SPRUANCE class of vessels. There are consistently over 100 vessels in this group, considering retirements and new vessels added to the fleet on a regular basis. Because of the oil and water interface, there is some mixing of the fuel and water. This mixing includes free oil and emulsified oil. The free oil can be separated from the water easier than the emulsified oil. However, because testing of the ballast water has frequently turned up emulsified oil, and, at even less than 10 ppm, emulsified oil can leave a sheen in the water, the focus of the project was directed towards a capability to treat both types of oil.

A number of treatment solutions were studied including:

- oil/water separators,
- membranes,
- coalescing tanks,
- dissolved air flotation,
- carbon filters, and
- municipal sewers.

A combination of coalescing tanks and dissolved air flotation working in series surfaced as the best treatment method. Use of a storage system to hold the water until processed by a slower system was also studied. An analysis of the different types is presented with a cost benefit analysis. The cost analysis is most sensitive to:

- the potential efficiency a yard gains from treating the water quickly,
- the number of yards that can share a portable system,
- initial system cost, and
- the cost of the treatment method currently used.

In the final analysis, there are a number of options to choose from for a shipyard facing this problem. Tools are provided for a yard to perform its own analysis for local conditions.

# WASTE WATER TREATMENT TECHNOLOGY SURVEY

## TABLE OF CONTENTS

Report Documentation Page .....	i
Executive Summary .....	ii
Table of Contents.....	iii

Introduction .....	1
Technical Approach .....	1
Cost Benefit Analysis.....	4
Conclusions .....	17

### Appendices

A. Phase I Report .....	A-1
B. Literature Search Results .....	B-1
C. Filtration Systems Report.....	C-1
D. System Descriptions.....	D-1
E. Companies Supplying Information .....	E-1

## INTRODUCTION

The Waste Water Treatment Technology Survey was performed by the Marine Systems Division (MSD) of the University of Michigan Transportation Research Institute (UMTRI) for Bath Iron Works (BIW). This project was formulated as Project N1-93-3, Waste Water Treatment Technology Survey (High Volume/Oily Waste) as part of the National Shipbuilding Research Program (NSRP) initiative directed by the Society of Naval Architects and Marine Engineer's (SNAME) Panel SP-1 on Facilities and Environmental Effects. National Steel and Shipbuilding Company (NASSCO) was Project Manager.

The objective of the Waste Water Treatment Technology Survey was to investigate treatment methods that could quickly treat the ballast water from naval vessels that have compensated fuel tank arrangements. When vessels with compensated fuel tanks enter a shipyard for a repair availability, the tanks must be emptied, cleaned and gas freed before they can be worked on. At some shipyards, this process can take as long as three days to complete and is usually paced by the treatment system used. Most of the shipyards surveyed for the project were limited from performing much other work on the vessels during the deballasting process because many or all of the ship's fuel tanks were open. These limitations place this process on the critical path. Therefore, if not performed quickly, deballasting either delays vessel completion or requires expensive overtime labor expenditures to make up the lost time.

The basic goal of the project was to identify treatment technologies or combinations that could process the ballast water at 500 gallons per minute (gpm) and clean it sufficiently to discharge it back into the local waters at less than 10 parts per million (ppm) and without leaving a sheen.

Ships with compensated fuel tanks have piping arrangements that automatically allow ballast water to flow into the fuel tanks as the fuel is consumed so that the vessels maintain a constant draft. Conversely, as these vessels take on fuel, the ballast water is displaced by the fuel. These vessels include the DDG-51, ARLEIGH BURKE class; the four DDG-963 KIDD class; the CG-47, TICONDEROGA class; and the DD-963 SPRUANCE class of vessels. There are consistently over 100 vessels in this group.

Because of the oil and water interface, there is some mixing of the fuel and water. This mixing includes free oil and emulsified oil. The free oil can be separated from the water with relatively inexpensive equipment. The emulsified oil is more difficult to handle. The Navy is doing research through a Washington, D.C. area design firm to try to eliminate as much emulsified oil as possible from the water stream through changes in tank and fuel system piping design on the ships. If successful, this ongoing research may change the requirements for this particular analysis. However, testing of water ballast during deballasting operations has frequently turned up emulsified oil. At less than 10 ppm, the discharge limit presently allowed, emulsified oil can leave a sheen in the water, and a sheen is not allowed regardless of concentration. Therefore, the focus of the project was directed towards a capability to treat both free oil and emulsified oil.

## TECHNICAL APPROACH

Our technical approach was basically the same as that described in the SP-1 project statement. The tasks were set forth as listed below.

- Task A: Literature Review.
- Task B: Shipyard Surveys.
- Task C: Industry Surveys.
- Phase I Report.
- Phase II Report.

The Research efforts were coordinated between UMTRI and BIW. Tasks were integrated as building blocks leading to identification of the most cost effective treatment processes.

### **Task A: Literature Review**

Various technical libraries worldwide were queried and a list of references studied. A number of state-of-the-art processes that meet the current and anticipated effluent requirements of the project were reported in the Phase I Report which is attached as Appendix A. The relevant findings from the literature are listed in Appendix B. A study of these reports, and some independent interviews with experts in the field of water processing, assisted in determining which processes were likely to perform to the project specifications.

The most promising low cost / high volume type of processing is the coalescing tank. Coalescing tanks are frequently used outside of the marine industry to purify oily waste streams. They are tanks fitted with internal plates inclined at an angle across the tank flow. The tanks themselves are normally fiberglass or epoxy coated steel to reduce corrosion. The plates are oleophilic (oil attracting) and are normally constructed from polypropylene. The oil and water pass over the corrugated plates and the oil droplets combine into large droplets. The larger the droplet the faster it will rise. This is a result of Stoke's Law. The oil is collected at a weir at the top. Solids fall out of solution because of the changes in velocity as the water flows over the corrugations and are collected at the bottom. Estimated cost of such a system to handle 500 gpm was in the range of \$24,000 to \$36,000. However, coalescing tanks do not remove emulsified oil, and at the stage of the project when the Phase I report was completed, it had not been determined whether or not there was emulsified oil in the waste stream.

In order to handle emulsified oil, a Dissolved Air Flotation (DAF) system is generally thought to be the best technology. Infuse air flotation, discussed in Appendix C, is a modified form of DAF. This technology is commonly used on offshore oil drilling platforms. These systems use a combination of Stoke's Law, Henry's Law, and Nucleus Theory. The principle of operation is that air is dissolved into the oily water while it is under pressure. The water is relieved from the pressure and the dissolved air comes out of solution. This is Henry's Law. This is commonly demonstrated when a bottle of soda is opened. The pressure inside of the bottle is reduced when it is opened and the carbonated gases form bubbles as they come out of solution. As in a bottle of soda, the bubbles rise to the surface and the larger they are the faster they rise. This is Stoke's Law. As these bubbles of air rise they collide with, and attach to, the suspended oil and in turn carry it to the surface. This is nucleus theory. DAFs are used in conjunction with coalescing tanks to remove both the free and emulsified oil from a waste stream. A commercial off-the-shelf combination system for processing at 100 gpm costs about \$100,000.

### **Task B: Shipyard Surveys**

Both on-site and mail/phone surveys were performed for this project. The mail surveys produced few usable results. The on-site and phone surveys were a bit more useful. The primary results were basically that:

- There are a few key manufacturers of treatment systems,
- The systems require consistent monitoring,
- A single system that can process 500 gpm is a rarity, and
- There are more reasons than treating ballast waste for having a treatment system.

This last item made it difficult to confine the scope of the project. The intended focus was to investigate systems for treating oily ballast water from the occasional source of naval vessels with



compensated fuel tanks. However, most shipyards that occasionally deal with compensated-fuel-tank ships are also faced with numerous other waste water processing needs and opportunities, both within the yard and in the surrounding port areas. The yards have ready access to these out-of-yard sites with inexpensive water transportation by barge. Therefore, a much larger potential market appears to be available for using a complete waste water processing systems.

### **Task C: Industry Surveys**

The industry survey on the identified treatment system vendors was successful. These companies were clearly identified by the shipyards in the surveys because their systems are either in use there or have been recommended by contemporaries. The three identified vendors were:

- Filtration/Treatment Systems of Kent, WA,
- Hydro-Flo Technologies of Carol Stream, IL, and
- Jalbert Environmental of Virginia Beach, VA.

Each of their systems is further analyzed in the report. There are numerous other manufacturers of other viable systems, but they are too numerous to list and classify in this report. An Internet search produced 736 companies that claimed some type of capability under the search for Waste Water Treatment Systems. Some of these companies are manufacturers, some are distributors, some market systems that may or may not be suitable to the type and volume of waste water considered here. However, the results of this search indicate quite a range and number of other treatment options. Investigating this large group was beyond the scope of this project.

### **Phase I Report**

A number of treatment solutions were studied in Phase I of the project. The Phase I report is attached as Appendix A. Appendix C is an independent and more technical analysis of the subject prepared by Jeffrey Pettey of Filtration/Treatment Systems, who was contracted to design a single high flow system that met the basic performance specifications of the project.

These reports were discussed at the July SP-1 meeting in Seattle where Mr. Pettey gave a presentation on treatment problems and solutions. This was the basis for the Appendix C report. The Phase I report predicted additional information would be available on the operating characteristics and sewer systems of 12 shipyards, but the lack of response from the shipyards on the survey prevented getting this additional information.

When the Phase I Report was issued, actual ballast water sample testing had not been performed. Testing of typical ballast water, as it was being pumped from both a CG-47 class and a DDG-51 class vessel, showed the presence of some amounts of emulsified oil, so the hoped for (from the Phase I report) inexpensive solution did not provide an adequate treatment solution.

### **Task D: On-Site Monitoring**

The two basic types of existing, viable systems were monitored at Puget Sound Naval Shipyard and at National Steel and Shipbuilding. Both the Jalbert and Hydro-Flo systems were observed in operation processing different types of waste water streams. They were used in conjunction with temporary storage systems, those being tanks or barges or both.

### **Phase II Report**

This document is the Phase II report which contains the Phase I report, Task D and the economic analyses.

## **COST BENEFIT ANALYSIS**

The basic approach to the economic analysis was to identify the capable systems and perform a cost / benefit analysis on some of the most promising types. The four systems analyzed were:

- A single unit portable (one tractor trailer) system designed specifically for the 500 gpm system performance specifications by Filtration/Treatment Systems of Kent, WA;
- A dual unit (two tractor trailers) 500 gpm portable system packaged by Jalbert Environmental of Virginia Beach, VA;
- A 100 gpm, commercial-off- the -shelf system, combined with storage, that could also handle most other contaminated waste water streams, from Hydro-Flo Technologies of Carol Stream, IL; and
- A 100 gpm, commercial-off- the -shelf system, combined with storage, from Jalbert.

The various system descriptions and performance specifications, along with drawings, are attached in Appendix D.

The cost analysis spreadsheets that follow display an extensive cost stream analysis of the options to purchase one of the four systems. Some of the variables are subjective in the determination of magnitude and their effect on the bottom line. The measure of merit, or bottom line, is the Net Present Value (NPV), which is an accounting method for comparing future costs (and benefits) in present dollars. The greater the NPV, the better the option. A sensitivity analysis is then performed on each cost spreadsheet to determine the effect that modifying each variable between likely high and low values has on the NPV. All other variables are held constant while one variable is cycled through its possible high and low ranges. Those results are displayed in a separate bar chart. Definitions of the variables and their effect on the NPV and sensitivity analysis are described below. Discussion of the four alternatives follows.

Anyone wishing to perform an analysis of the systems using their own values for the variables can obtain the spreadsheets from UMTRI:

- By mail through the address on the cover,
- Phone 313-763-2465 and ask for the librarian,
- Email to: doc.center@umich.edu, or
- From the Internet through the NSRP Documentation Center at <http://www.nsnet.com/docctr/>.

The systems are analyzed under the presumption that a yard can get the ballast water out of the tanks at 500 gpm. This part of the processing is not dealt with in the analysis as methods between yards vary somewhat. The analysis then becomes a question of how fast the waste stream is processed and the related economics.

### **Line Item and Variable Definitions**

The variables are defined in the order that they appear in the spreadsheet.

*Initial Cost.* This is the base cost of the waste water treatment system under consideration and does not include any freight or taxes.

*Cost of Storage Tank.* This is the cost for a storage tank capable of holding most of the ballast water for processing by a slower system. The baseline cost is for a 500,000 gallon tank. The sensitivity analysis ranges deal with larger and smaller tanks and inclusion of special features.

*Single Yard Cost.* This is the cost of the system if shared with another shipyard or cleanup contractor, and is the *initial cost* divided by the *number of yards*. If this figure is the same as the *initial cost*, (meaning the *number of yards* is one), that particular analysis looks at only one shipyard purchasing and operating a system.

*Trailer Ops Costs.* This is the cost for maintaining a semi trailer dedicated to an attached portable waste water processing system. The added cost for the fifth year is for a minor overhaul. Values for this variable is left out of the analysis for fixed systems.

*System Ops Cost.* These are the expected expenses including projected labor involvement, chemical additives (if applicable) and electric power consumption. It is determined by multiplying the *number of ships* by the *volume /1,000* and by the *cost per volume* plus a fixed amount that estimates electrical and labor costs. The sensitivity analysis looks at wide variations of this cost.

*Recovered Oil.* This is the income from selling the recovered oil. It is determined by multiplying the Number of Ships by the Volume by the Volume Recovered Oil by the Price Recovered Oil.

*Yard Efficiency Gain.* The potential gain in efficiency in a shipyard is the main thrust area behind this research. This gain is expected from compressing the time spent processing ballast water. The gains are estimated from both the overhead associated with having a ship in repair status (but not performing any maintenance or repair work except for pumping off the ballast water) and from avoiding overtime and the inefficiencies from rushed activities at the end of an availability. The sensitivity analysis looks at a wide range of potential efficiency gains.

*System Maintenance.* Waste water processing systems have various arrangements of pumps, valves, controllers, pipe connections and sensors. These are items that eventually incur maintenance costs. These are estimated expenses taken directly from manufacturer interviews and have very little sensitivity range.

*Transportation Cost.* If the treatment system is a portable one that can be shared between yards or other facilities, a transportation cost is entered, otherwise, it is zeroed. The transportation cost is a multiple of the *transportation* variable, the *miles*, and the *number of ships* processed per yard per year.

*Total.* These are totals for each annual column. The Year 0 column is for initial expenses to purchase the system and is the reference point (the present) for the NPV calculation.

*Salvage Value.* This is the expected value of the treatment system after the time period of the analysis. It is determined by multiplying the *initial cost* by the *salvage rate*.

*Net Present Value.* The net present value (NPV) is an accounting method for bringing future expense or revenue streams back to a present value. It is the sum of the incremental cash flows over the life of the project reduced to current dollars by the interest rate. If the NPV is positive, the planned venture returns a profit and the choice between alternatives is the one that returns the highest NPV. If the NPV is negative, another measure of merit can be used to determine the potential gain, or, in this case, loss avoidance or reduction of added expense.

*Pay Back Period.* This is the time it would take (in number of ships processed) to pay back the expense of purchasing and operating such a system. If the NPV is positive, this item is indicated as "NA" as the operated system produces profit. If one uses the charts available and determines a negative NPV, this value returns the number of ships a yard would have to process to offset a contractors charge to perform the work.

*Transportation.* This is the cost per mile to hire a tractor and driver to transport a portable treatment system (on its own dedicated trailer(s) which is (are) included in the *initial cost* ) from yard to yard. It is determined by multiplying the *transportation* variable by the *miles* by the number of trailers by the *number of ships* processed.

*Interest.* This is the interest rate that could be used if the money invested in the system were invested instead in some other type of secure investment, such as a bond. It is also used in the NPV calculation.

*Miles.* This is the total distance between each of the yards sharing a single system and is figured into the transportation cost.

*Number of Yards.* This is the number of yards or other facilities sharing a single system.

*Number of Ships.* This is the number of ships with compensated fuel systems, or waste water streams of similar volume and contaminants, processed in a year in one yard.

*Volume per Ship.* This is the total amount of waste ballast water to be processed per ship (or event). The base amount for the project is 500,000 gallons.

*Cost per Volume.* This is the cost of processing chemicals required for some systems.

*Volume Recovered Oil.* This is the percentage of the *volume per ship* that can be recovered for resale.

*Price Recovered Oil.* This is an average value for the recovered oil.

*Contractor Charge.* This is an average charge for an outside contractor to come in and treat the stated amount of oily ballast water. It is used to determine the *pay back period* if the NPV is negative.

*Yard Efficiency Gain.* This is the variable table entry for the *yard efficiency* line item in the cost spreadsheet.

*Salvage Rate.* This is the percentage rate which determines the *salvage value*.

## **System Operation and Economic Analyses**

This section looks at the economic analysis spreadsheet for the four oily waste water treatment systems listed above. A similar arrangement could be used for analyzing other systems. In these analyses

### **Filtration / Treatment Systems Single Unit 500 GPM Portable System**

The mobile waste water treatment technology designed by Filtration/Treatment Systems was custom designed for this project to meet (at that time in the research) the desired capabilities of:

- Portability, in that it could be contained and transported on a single flat bed trailer;
- A 500 gpm flow rate; and
- Treating the lightly oiled waste water so that it could be placed back in the local water supply.

A full explanation of the system and a diagram are presented in Appendix C. The basics of the system operation start with the oily ballast water entering the receiving tank to await processing.

The non-emulsifying feed pumps transfer the oily ballast water to the liquid/liquid centrifuge for separation. The liquid/liquid centrifuge separates the oily ballast water into two separate process streams. The waste oil stream is directed to a waste oil storage tank while the contaminated water flows into the equalization clearwell. From this clearwell, the contaminated water is transferred to the induced air flotation process. The influent water is chemically pretreated to enhance the induced air separation process. The contaminant particles, which naturally repel one another, are chemically compelled to combine as precipitate in the water stream. Air is induced into the water stream where the bubbles attach to fine particulates which rise to the surface and create a floating scum layer. This layer is periodically skimmed off and into the float collection tank. The float is eventually transferred to the float sludge tank. Heavier sludge collects in the sludge hoppers at the bottom of the unit and is transferred directly to the float sludge tank. The remaining water is transferred to the polymerized absorbent polish for further treatment. The water flows through a polymerized absorbent media and is cleaned of any residual petroleum products.

The cost benefit analysis in Table I shows the relatively high initial cost of this specially designed system. Part of that cost is in the specialized centrifuges and induced air flotation tank that enable the fast flow in a compact design, but are somewhat expensive items. However, if the initial cost is shared between three shipyards, or one shipyard and one or more environmental companies that use the system often enough to offset the cost, the baseline NPV is over \$51,000. This may seem to be an overoptimistic evaluation - that is why the analysis spreadsheets have been made available for others to use. Table II shows the sensitivity analysis of this cost benefit analysis. The five variables below the baseline value are only listed, not charted, because their effect on the NPV is minimal and showing too much data makes the charts too small.

At a glance, the bar chart below the Table shows those variables with the greatest effect on the NPV. The *number of ships* variable has the greatest effect. It was run between 1 every two years (0.5 per year) to two per year. Even at 1 ship every two years, a system that could be purchased and shared between three yards could be justified based on just processing compensated fuel tank naval vessels. Additional processing jobs would be mostly profit.

The *yard efficiency gain*, *number of yards* and *single yard cost* variables also have a significant effect on the NPV. The *yard efficiency gain* is a subjective variable the value of which must be determined individually by each yard. There should be some gain from quicker than normal processing of the ballast water. This gain depends on how fast the water was processed by any previous method(s) compared to the efficiency gains expected from quicker processing.

The *single yard cost* is a dependent variable relying on the *initial cost* and *number of yards* involved in a purchase. A high initial cost combined with a low *number of yards* involved in a purchase would drive the NPV down considerably. Any other pessimistic study of a purchase decision, where a number of the key variables are considered at their low NPV producing values, would also drive the NPV down. Such an analysis would have to involve use of the system for processing chores beyond a small number of ships with compensated fuel tanks.

### **Jalbert Two Unit Portable 400 GPM System**

Table III shows a slightly different analysis that looks at a treatment system from Jalbert mounted on two trailers. This system is an enlarged and portable version of the 100 gpm unit described in Appendix D. The baseline NPV is over \$27,000. The Yard Efficiency Gain has been reduced somewhat to investigate a lower range for this efficiency on the NPV. At a lower efficiency, the NPV can get negative, and a look at the *pay back period* is more appropriate. The sensitivity analysis in Table IV shows similar results to the previous system, but the *miles* variable has a more adverse effect with two trailers to transport.

### **Jalbert 100 GPM System With Storage**

This Jalbert system is a standard 100 gpm system used in conjunction with a storage tank. The cost benefit analysis is in Table V. The basic cost for the storage tank ranges from \$100,000 for a storage tank or a used barge to \$250,000 for a new barge. With a few additions, this system could handle a variety of waste water streams beyond the slightly oiled water for this project. The baseline NPV is over \$34,000. The sensitivity analysis in Table VI shows a decided sensitivity to working on fewer than one ship per year.

### **Hydro-Flo 100 GPM System With Storage**

This system is similar to one viewed at Puget Sound Naval Shipyard. It is already configured and priced to handle a variety of contaminants in a waste water stream. Tables VII and VIII show the economic analyses. The advantage of such a system is that it can be used to handle a variety of waste water problems, not just the water from ships with compensated fuel tanks.

**Table I**

**Cost Benefit Analysis  
Filtration / Treatment Systems**

	Year 0	Year 1	Year 2	Year 3	Year 4	Year 5	Salvage Value
Initial Cost	(\$460,000)						\$276,000
Single Yard Cost	(\$153,333)	\$0	\$0	\$0	\$0	\$0	\$92,000
Cost of Trailer		\$0	\$0	\$0	\$0	\$0	
Trailer Op Costs		(\$133)	(\$133)	(\$133)	(\$133)	(\$1,667)	
System Ops Cost		(\$1,200)	(\$1,200)	(\$1,200)	(\$1,200)	(\$1,200)	
Recovered Oil		\$3,000	\$3,000	\$3,000	\$3,000	\$3,000	
Yard Efficiency Gain		\$40,000	\$40,000	\$40,000	\$40,000	\$40,000	
System Maintenance		(\$500)	(\$500)	(\$1,000)	(\$500)	(\$3,000)	
Transportation cost		(\$3,600)	(\$3,600)	(\$3,600)	(\$3,600)	(\$3,600)	
Total (per yard)	(\$153,333)	\$37,567	\$37,567	\$37,067	\$37,567	\$33,533	\$92,000
Net Present Value	\$51,493						

Pay Back Period                      NA              ships

Variables

Transportation	\$1.20	per mile
Interest	8%	per year
Miles	3,000	per year
Number of Yards	3	sharing system cost
Number of Ships	1	ship per year per yard
Volume per Ship	500,000	gallons
Cost per Volume	\$1.60	per 1,000 gallons
Volume Recovered Oil	1.0%	Percentage of Total Volume
Price Recovered Oil	\$0.60	per gallon
Contractor Charge	(\$50,000)	processing per Ship
Yard Efficiency Gain	\$40,000	per ship
Salvage Rate	60%	% of original cost

**Table II  
FILTRATION SYSTEMS SENSITIVITY ANALYSIS**

VARIABLE	UNITS	VARIABLE RANGE			NET PRESENT VALUE	
		LOW	BASELINE	HIGH	LOW	HIGH
Initial Cost	\$	\$360,000	\$460,000	\$560,000		
Single Yard Cost	\$	\$120,000	\$153,333	\$186,667	\$72,223	\$30,763
Transportation	\$ / mile	\$1.00	\$1.20	\$1.40	\$53,889	\$49,098
Interest	%	6%	8%	10%	\$66,334	\$38,125
Miles	miles	1,000	3,000	5,000	\$61,067	\$41,911
Number of Yards	#	2	3	4	\$3,026	\$75,727
Number of Ships per Year	#	0.5	1	2	(\$25,566)	\$205,612
Volume per Ship	gallons	400,000	500,000	600,000	\$49,736	\$53,250
Volume Recovered Oil	%	0.5%	1.0%	2.0%	\$45,504	\$63,471
Yard Efficiency Gain	\$	\$30,000	\$40,000	\$50,000	\$11,566	\$91,420
Salvage Value	%	50%	60%	70%	\$41,831	\$61,156
<b>BASELINE</b>					<b>\$51,493</b>	<b>\$51,493</b>
Price Recovered Oil	\$ / gal.	\$0.50	\$0.60	\$0.70	\$49,497	\$53,489
Cost per Volume	\$ / gal.	\$1.40	\$1.60	\$1.80	\$51,892	\$51,094
System Maintenance (avg)	\$	\$800	\$1,100	\$1,600	\$52,686	\$49,497
System Ops Cost (avg)	\$	\$800	\$1,200	\$1,600	\$53,090	\$49,896
Trailer Op Costs (avg)	\$	\$220	\$440	\$660	\$52,281	\$50,705

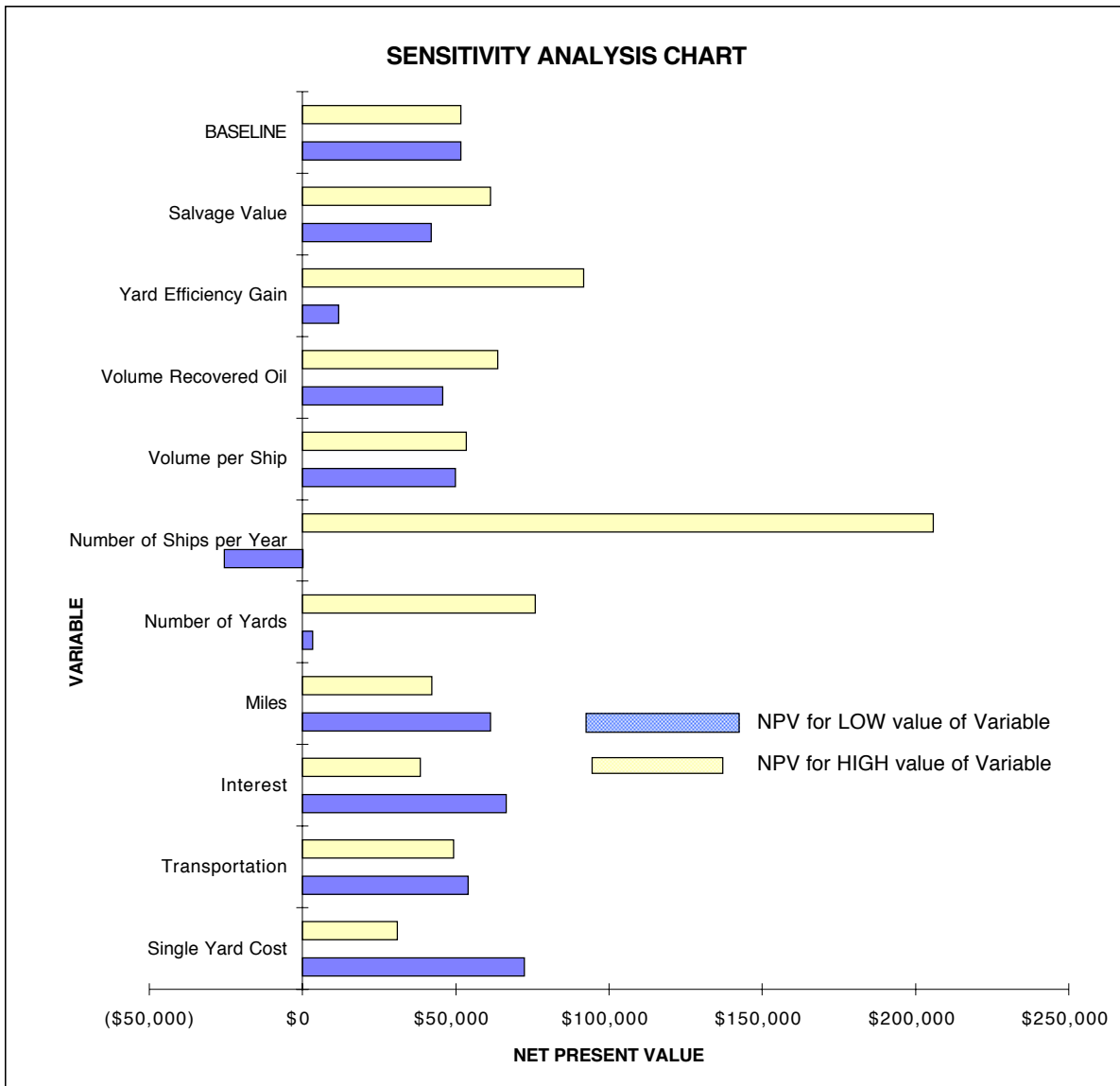



**Table III**

**Cost Benefit Analysis  
Jalbert Two Trailer System**

	Year 0	Year 1	Year 2	Year 3	Year 4	Year 5	Salvage Value
Initial Cost	(\$285,000)						\$171,000
Cost of Trailers	(\$40,000)	\$0	\$0	\$0	\$0	\$0	\$24,000
Single Yard Cost	(\$108,333)	\$0	\$0	\$0	\$0	\$0	\$65,000
Trailer Ops Costs		(\$267)	(\$267)	(\$267)	(\$267)	(\$3,333)	
System Ops Cost		(\$1,250)	(\$1,250)	(\$1,250)	(\$1,250)	(\$1,250)	
Recovered Oil		\$3,000	\$3,000	\$3,000	\$3,000	\$3,000	
Yard Efficiency Gain		\$40,000	\$40,000	\$40,000	\$40,000	\$40,000	
System Maintenance		(\$1,000)	(\$1,000)	(\$2,000)	(\$1,000)	(\$6,000)	
Transportation Cost		(\$7,200)	(\$7,200)	(\$7,200)	(\$7,200)	(\$7,200)	
Total	(\$108,333)	\$33,283	\$33,283	\$32,283	\$33,283	\$25,217	\$65,000
Net Present Value	\$59,235						

Pay Back Period                      NA            ships

Variables

Transportation	\$1.20	per mile
Interest	8%	per year
System Weight	35,000	pounds
Miles	3,000	per year
Number of Yards	3	sharing system cost
Number of Ships	1	ship per year per yard
Volume per Ship	500,000	gallons
Cost per Volume	\$1.70	per 1,000 gallons
Volume Recovered Oil	1.0%	Percentage of Total Volume
Price Recovered Oil	\$0.60	per gallon
Contractor Charge	(\$50,000)	Processing per Ship
Yard Efficiency Gain	\$40,000	per ship
Salvage Rate	60%	% of original cost

**Table IV  
JALBERT TWO TRAILER SYSTEM SENSITIVITY ANALYSIS**

VARIABLE	UNITS	VARIABLE RANGE			NET PRESENT VALUE	
		LOW	BASELINE	HIGH	LOW	HIGH
Initial Cost	\$	\$290,000	\$325,000	\$350,000	\$34,548	\$22,110
Single Yard Cost	\$	\$96,667	\$108,333	\$116,667	\$34,548	\$22,110
Transportation	\$ / mile	\$1.00	\$1.20	\$1.40	\$32,084	\$22,502
Interest	%	6%	8%	10%	\$37,124	\$18,441
Miles	miles	1,000	3,000	5,000	\$46,458	\$8,128
Number of Yards	#	2	3	4	(\$7,969)	\$44,924
Number of Ships	#	0.5	1	2	(\$26,509)	\$134,896
Volume per Ship	gallons	400,000	500,000	600,000	\$25,576	\$29,010
Volume Recovered Oil	%	0.5%	1.0%	2.0%	\$21,304	\$39,271
Yard Efficiency Gain	\$	\$ 22,000	\$ 32,000	\$ 42,000	(\$12,634)	\$67,220
Salvage Value	%	50%	60%	70%	\$20,466	\$34,120
<b>BASELINE</b>					\$27,293	\$27,293
Price Recovered Oil	\$ / gal.	\$0.50	\$0.60	\$0.70	\$25,296	\$29,289
Cost per Volume	\$ / gal.	\$1.50	\$1.70	\$1.90	\$27,692	\$26,894
System Maintenance (avg)	\$	\$1,600	\$2,200	\$3,200	\$29,526	\$23,570
System Ops Cost (avg)	\$	\$850	\$1,250	\$2,500	\$28,890	\$22,302
Trailer Op Costs (avg)	\$	\$440	\$880	\$1,320	\$28,869	\$25,717

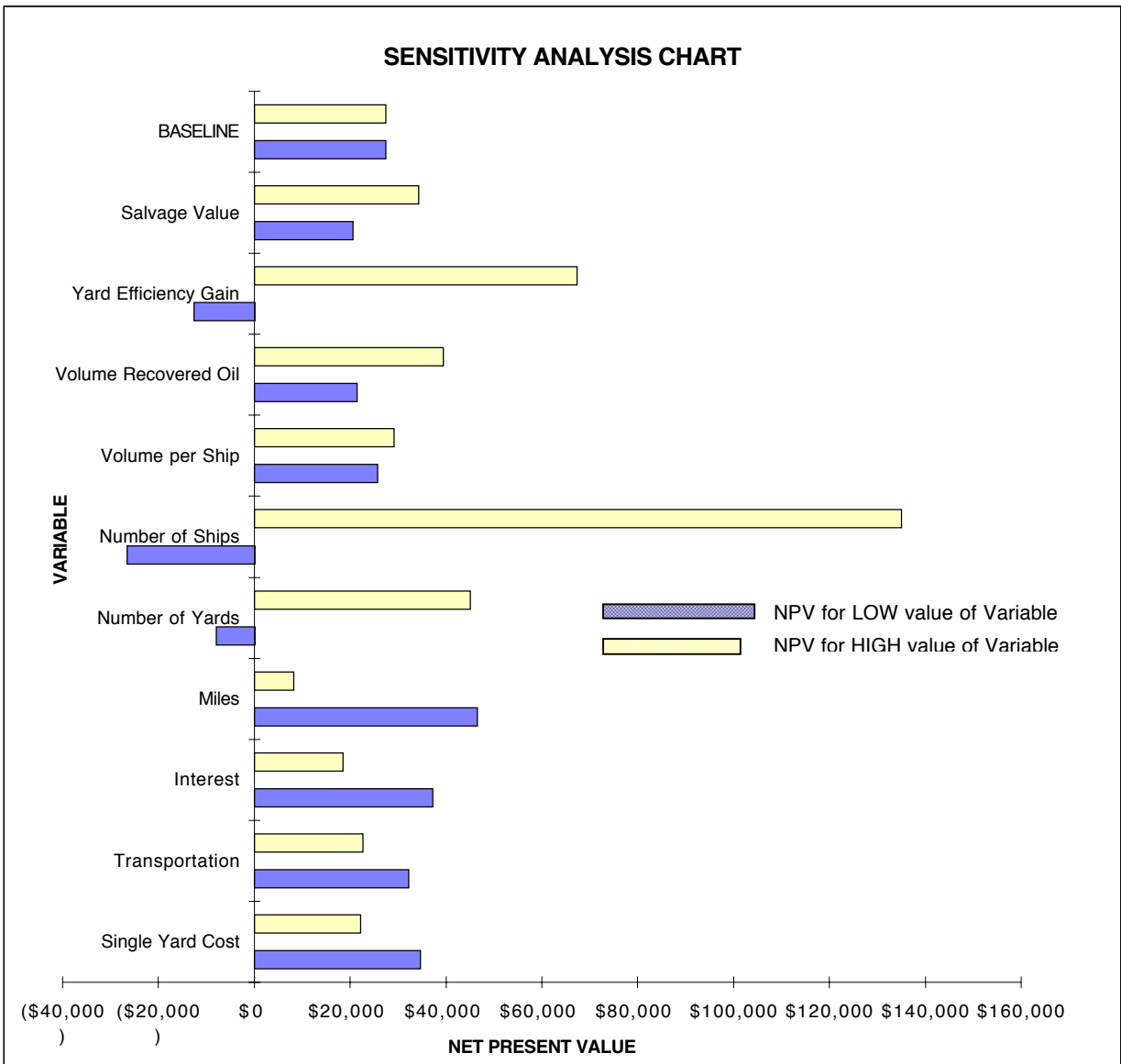

**Table V**

**Jalbert Small System with Storage Cost Benefit Analysis**

	Year 0	Year 1	Year 2	Year 3	Year 4	Year 5	Salvage Value
Initial Cost	(\$100,000)	\$0	\$0	\$0	\$0	\$0	\$60,000
Cost of Storage Tank	(\$100,000)	\$0	\$0	\$0	\$0	\$0	\$60,000
System Ops Cost		(\$1,200)	(\$1,200)	(\$1,200)	(\$1,200)	(\$1,200)	
Recovered Oil		\$3,000	\$3,000	\$3,000	\$3,000	\$3,000	
Yard Efficiency Gain		\$40,000	\$40,000	\$40,000	\$40,000	\$40,000	
System Maintenance		(\$1,000)	(\$2,000)	(\$1,000)	(\$2,000)	(\$4,000)	
<b>Total</b>	<b>(\$200,000)</b>	<b>\$40,800</b>	<b>\$39,800</b>	<b>\$40,800</b>	<b>\$39,800</b>	<b>\$37,800</b>	<b>\$120,000</b>
<b>Net Present Value</b>	<b>\$34,889</b>						

Pay Back Period                      NA        ships

Variables

Transportation	\$0.00	per mile
Interest	8%	per year
System Weight	NA	pounds
Miles	0	per year
Number of Yards	1	sharing system cost
Number of Ships	1	per year
Volume per Ship	500,000	gallons
Cost per Volume	\$1.60	per 1,000 gallons
Volume Recovered Oil	1.0%	percentage of total volume
Price Recovered Oil	\$0.60	per gallon
Contractor/Current Charge	\$50,000	processing per ship
Yard Efficiency Gain	\$40,000	per Ship per day
Salvage Rate	60%	% of original cost

**Table VI**  
**Jalbert Small System with Storage Sensitivity Analysis**

VARIABLE	UNITS	VARIABLE RANGE			NET PRESENT VALUE	
		LOW	BASELINE	HIGH	LOW	HIGH
Initial Total Cost	\$	\$180,000	\$200,000	\$300,000	\$47,327	\$3,794
Interest	%	6%	8%	10%	\$52,536	\$19,029
Number of Ships per year	#	0.5	1	2	\$49,357	\$203,381
Volume per Ship	gallons	400,000	500,000	600,000	\$33,132	\$36,646
Volume Recovered Oil	%	0.5%	1.0%	2.0%	\$28,900	\$46,867
Yard Efficiency Gain	\$	\$ 30,000	\$ 40,000	\$ 50,000	(\$5,038)	\$74,816
Salvage Value	%	50%	60%	70%	\$22,285	\$47,492
<b>BASELINE</b>					\$34,889	\$34,889
Price Recovered Oil	\$ / gal.	\$0.50	\$0.60	\$0.70	\$32,892	\$36,885
Cost per Volume	\$ / gal.	\$1.40	\$1.60	\$1.80	\$35,288	\$34,490
System Maintenance (avg)	\$	\$1,000	\$2,000	\$3,000	\$38,702	\$31,075
System Ops Cost (avg)	\$	\$800	\$1,200	\$1,600	\$36,486	\$33,292

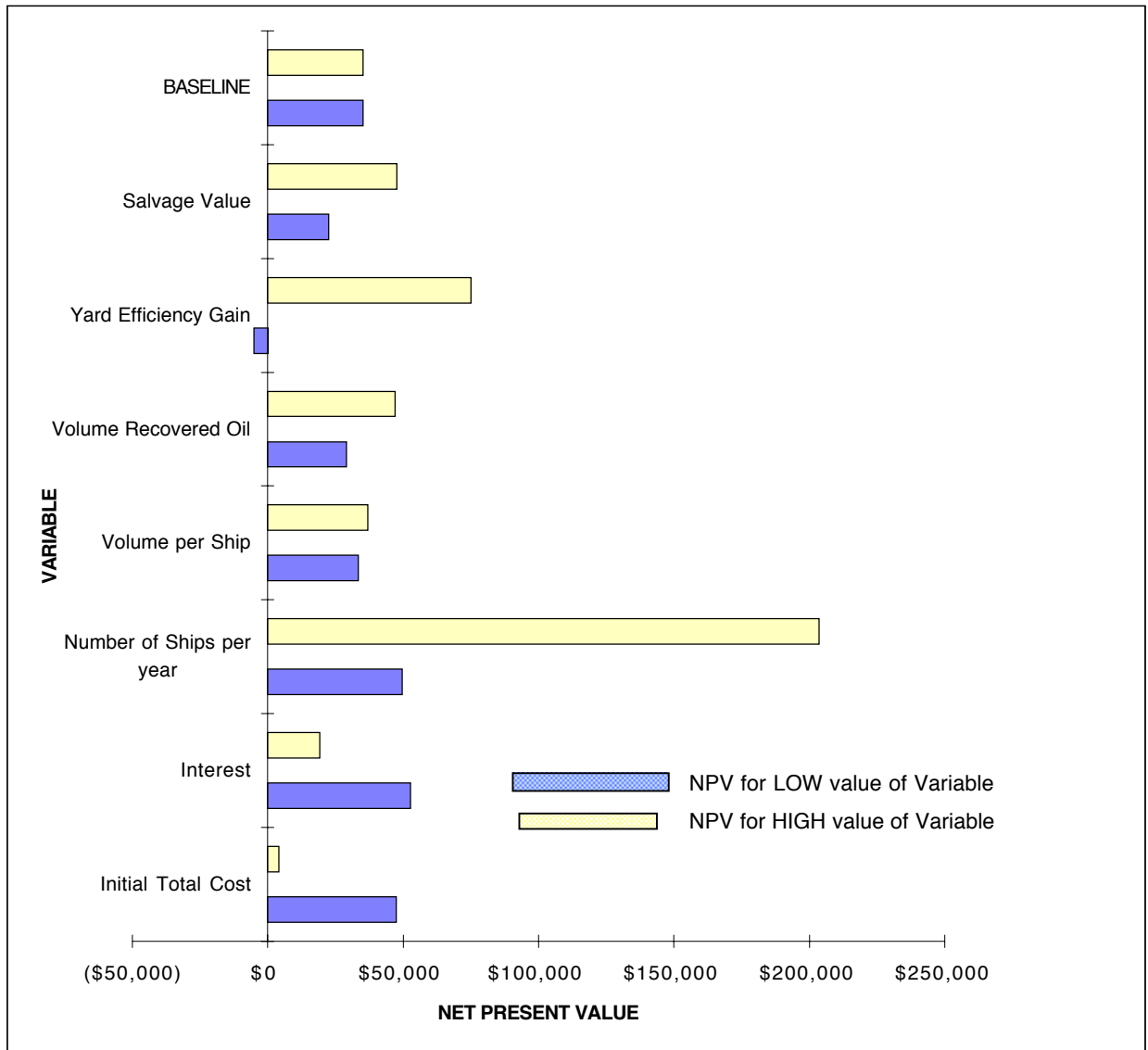

**Table VII**

**Hydro-Flo Cost Benefit Analysis**

	Year 0	Year 1	Year 2	Year 3	Year 4	Year 5	Salvage Value
Initial Cost	(\$235,000)	\$0	\$0	\$0	\$0	\$0	\$141,000
Cost of Storage Tank	(\$100,000)	\$0	\$0	\$0	\$0	\$0	\$60,000
System Ops Cost		(\$1,200)	(\$1,200)	(\$1,200)	(\$1,200)	(\$1,200)	
Recovered Oil		\$3,000	\$3,000	\$3,000	\$3,000	\$3,000	
Yard Efficiency Gain		\$60,000	\$60,000	\$60,000	\$60,000	\$60,000	
System Maintenance		(\$1,000)	(\$2,000)	(\$1,000)	(\$2,000)	(\$4,000)	
<b>Total</b>	<b>(\$335,000)</b>	<b>\$60,800</b>	<b>\$59,800</b>	<b>\$60,800</b>	<b>\$59,800</b>	<b>\$57,800</b>	<b>\$201,000</b>
<b>Net Present Value</b>	<b>\$30,787</b>						

Pay Back Period                      NA            ships

Variables

Transportation	\$0.00	per mile
Interest	8%	per year
System Weight	NA	pounds
Miles	0	per year
Number of Yards	1	sharing system cost
Number of Ships	1.0	per year
Volume per Ship	500,000	gallons
Cost per Volume	\$1.60	per 1,000 gallons
Volume Recovered Oil	1.0%	Percentage of Total Volume
Price Recovered Oil	\$0.60	per gallon
Contractor/Current Charge	\$50,000	processing per ship
Yard Efficiency Gain	\$60,000	per ship + other Use
Salvage Rate	60%	% of original cost

**Table VIII  
Hydro-Flo Sensitivity Analysis**

VARIABLE	UNITS	VARIABLE RANGE			NET PRESENT VALUE	
		LOW	BASELINE	HIGH	LOW	HIGH
Initial Total Cost	\$	\$290,000	\$335,000	\$360,000	\$58,772	\$15,239
System Ops Cost (avg)	\$	\$800	\$1,200	\$1,600	\$32,384	\$29,190
Interest	%	6%	8%	10%	\$58,885	\$5,567
Number of Ships per year	#	0.5	1	2	\$53,459	\$199,279
Volume per Ship	gallons	400,000	500,000	600,000	\$29,030	\$32,544
Volume Recovered Oil	%	0.5%	1.0%	2.0%	\$24,798	\$42,765
Price Recovered Oil	\$ / gal.	\$0.50	\$0.60	\$0.70	\$28,790	\$32,783
Cost per Volume	\$ / gal.	\$1.40	\$1.60	\$1.80	\$31,186	\$30,387
System Maintenance (avg)	\$	\$1,000	\$2,000	\$3,000	\$34,600	\$26,973
Yard Efficiency Gain	\$	\$ 30,000	\$ 60,000	\$ 90,000	(\$88,995)	\$150,568
Salvage Value	%	50%	60%	70%	\$9,676	\$51,897
<b>BASELINE</b>					\$30,787	\$30,787

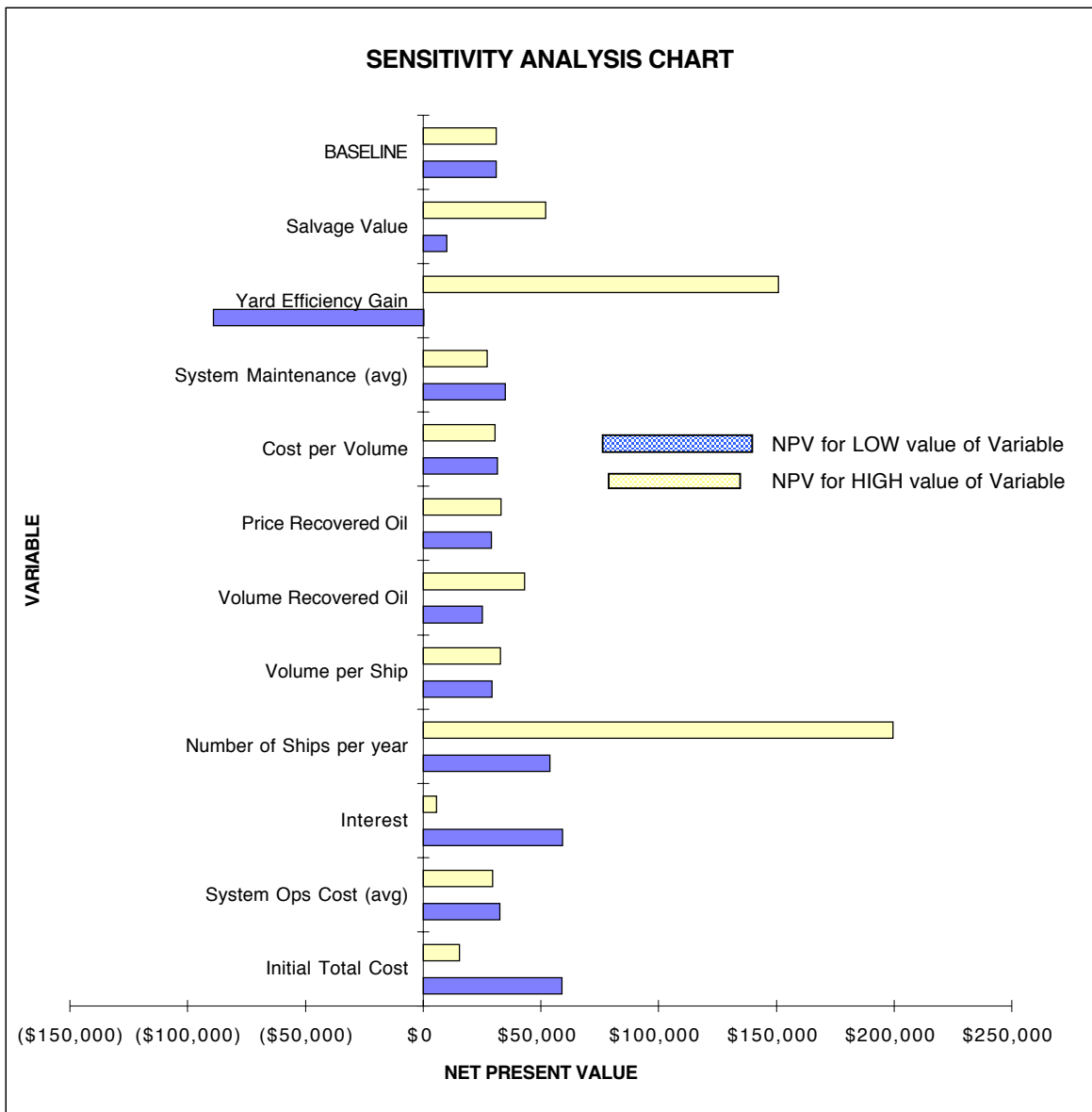

## **CONCLUSIONS**

There is no distinct advantage shown by any one system in these analyses. Each system has its own merits. If a yard doesn't have the space for storage, or does not care to operate an oil barge, a portable system is preferred. If a yard has space and capital, the low cost, slower system is a possible choice.

The spreadsheets are available on the internet at the NSnet web site for a yard to perform its own economic analysis.

## **ACKNOWLEDGMENTS**

The project team wishes to recognize and acknowledge the assistance of a number of outside participants who provided information for this report.

Scott Buchwalder and his team from Newport News Shipbuilding and Drydock were very helpful in taking samples from the USS MONTEREY, CG-49 as it was deballasted at NNS. They took 12 samples over a three day period and kept meticulous records so that the oil test results could be traced to time and tank.

Jeffrey Pettey of Filtration/Treatment Systems was helpful beyond the terms of the limited subcontract awarded for designing the single unit special system. Jeff prepared Appendix C, gave an informative presentation to the SP-1 Panel in Seattle, and provided a valuable review of the Phase II report.

Carey Krefft Hydro-Flo Technologies provided a generic description of the Hydro-Flo system and proved a worthy source of information for all types of systems.

Perry Mann of Jalbert Environmental was similarly helpful in providing a specialized design (the two trailer system) and much additional information about systems, customers and potential usage.

# **APPENDIX A**

## **WASTE WATER TREATMENT**

### **Phase 1 Report**



# WASTE WATER TREATMENT - Phase I Report

## Executive Summary

Phase I of the waste water treatment project has been completed<sup>1</sup>. Literature searches have been performed to gain background theoretical knowledge, and the results have been attached. In addition, equipment vendors have been contacted to gain knowledge of the capabilities of present treatment processes. Comparisons of similar products are included as are comments on their respective advantages and disadvantages. The purpose of this report is to present the data obtained during Phase I of the project, not to make specific recommendations.

The literature search provided a vast array of theoretical information relative to the task. This background knowledge made the effort spent on the remaining research more productive. Vendors were contacted regarding the performance of oil/water separators, membranes, coalescing tanks, activated carbon, and dissolved air flotation. Sewer system operators and waste management contractors were also contacted. The information they provided allowed comparison of different methods and different models of equipment using the similar treatment techniques. Membranes and oil/water separators do not provide adequate performance and should be removed from consideration. The remaining methods are researched in Phase II of the project.

## Discussion

This section first states the project background and requirements. Then the procedure and results of the literature search will be explained. Finally, specific equipment and the principles behind their operation will be covered.

### 1.0 Project Background and Methodology

#### 1.1 Project Background

Fuel is burned during the operation of a ship at sea. This burned fuel represents a significant change in the weight of the ship and can adversely affect trim and performance. To help neutralize this change in weight, some naval vessels use compensated fuel tanks. These tanks allow sea water to enter as fuel is burned to keep the tanks consistently full and the displacement of the vessel constant. Because the fuel is lighter than the saltwater (specific gravity .86 versus 1.03) it remains at the top of the tank. To ensure that the fuel going to the engines is clean, the takeoffs from the tanks are at the top and the fuel is pumped to day tanks where it is allowed to phase separate before being filtered and burned.

When these ships are brought into port for service the compensated fuel tanks must be totally emptied so the vessel can be drydocked and the tanks worked on. The liquid in the tanks at this point is a mixture of saltwater, naval distillate fuel, and some organic solids. There may also be zinc contamination. This water cannot be discharged directly into the local water because of the contaminants. At present, the methods to treat the water have been relatively slow shipyard systems, or hiring outside contractors, which is slow and expensive. The shipyards can pump out the tanks at 500 gallons per minute (gpm) but most processing occurs at 100 - 200 gpm. This difference represents lost time and money for both the Navy and the shipyard. The longer the ship remains out of commission at the shipyard, the longer it is not available to the fleet. The ship also occupies space the shipyard could use for other projects.

---

<sup>1</sup> This Appendix contains the Phase I report basically as it was presented to the SP-1 Panel. Thus, the verb tense is retained as in the original progress report. The contents have been edited somewhat.

To address this problem the Society of Naval Architects and Marine Engineers (SNAME) Panel SP-1 and the National Shipbuilding Research Program (NSRP) have contracted the University of Michigan Transportation Research Institute, Marine Systems Division (UMTRI) to research treatment systems that meet the following requirements:

- Treat waste water consisting of JP-5 fuel and saltwater ensuring an effluent with less than 10 parts per million (ppm) oil and no visible sheen.
- Have a maximum treatment rate of 500 gpm.
- Perform the above at lower cost than a subcontractor.

This report marks the end of Phase I of the project. It presents the data collected so far and identifies the future directions of the project.

## **1.2 Project Methodology**

To effectively complete this task, the subject of waste water and its treatment was first researched through a literature survey. Results of the literature survey can be found Appendix C. Vendors of water treatment products and shipyards who service ships with compensating fuel tanks were also contacted. The vendors were asked for specifications of capabilities to determine feasibility and a measure of merit. The shipyards were questioned on operational difficulties of treating oily water. Completion of these tasks marks the end of Phase I of the project. Phase II will involve a detailed survey of shipyards, more extensive vendor inquires, and a final recommendation.

### **1.2.1 Literature Search**

A literature survey was performed so the researchers could develop a broad based background on the subject. The extensive libraries of the University of Michigan were used to conduct a survey of existing publications dealing with the subject of waste water. The library's computerized card catalog, MIRLYN, was used to locate books cross-listed by keywords. These keywords were suggested by individuals with waste water experience. These books and journals were retrieved and their content evaluated for applicability.

In addition to the holdings of the University, a variety of papers were gathered from diverse sources. These sources include past Ship Production Symposia and technical papers furnished by vendors to support their equipment. A copy of the pertinent sources found through the literature survey is attached.

### **1.2.2 Shipyard Operations**

Two shipyards were surveyed on their deballasting operations. It is assumed for this phase of the project that their diverse experiences cover the range of the other 10 shipyards that are certified by the Navy to perform deballasting work.

Both Bath Iron Works (BIW) in Maine and National Steel and Shipbuilding (NASSCO ) in California deballast compensated fuel tanks using positive displacement pumps to eliminate mechanical emulsions. Access to the ship's tanks is gained through the tank tops and not the internal piping system. This procedure results in pumps and hoses on various decks and through passageways, interfering with other work. Their maximum pumping rates are 500 gpm, however these are rarely reached because of various operational difficulties.

Both yards strongly expressed the need to empty, treat, and dispose of the lightly oiled water as quickly as possible because of the strain that it places on the yard's operations.

The shipyards' experiences differ with respect to their treated water discharge restrictions. After removing the free oil, Bath cannot discharge to the local public water works because the water works uses bacteria to purify the water. Chloride concentrations or raw oil could kill many of the organisms. NASSCO operates under different local sewer laws. The San Diego Public Works accepts up to 500 ppm of oil and grease, and thus reduces the treatment burden. NASSCO is still unable to discharge directly into the sewer because the lines in the yard cannot handle a 500 gpm discharge in combination with the regular load. However, the allowable discharge limits are being reduced in San Diego, so direct discharge may not be a viable option for NASSCO much longer.

### **1.2.3 Treatment Methods**

A number of treatment methods were investigated. These ranged from contractor services to individual pieces of equipment to public water works. Each has its advantages and disadvantages.

All 12 shipyards will not be servicing ships with compensated fuel tanks at the same time. This means the equipment could be shared between yards reducing both initial capital outlay and maintenance costs. The present objective<sup>2</sup> is to be able to have one mobile system on each coast. For this to be possible equipment size will have to be compact to avoid added costs associated with permits for "wide" and "double wide" trailers .

## **2.0 Comparison of Treatment Methods**

The following is a detailed comparison of the various treatment techniques that were investigated.

### **2.1 Existing Contractors**

Two contractors were surveyed for the principles of their operation, its performance, and cost.

Clean Harbors, Inc.<sup>3</sup> of Massachusetts presently provides services to Bath Iron Works. They use a 20,000 holding tank to hold the oily water after it is pumped from the ship and then process it at 150 gpm or less taking about three days to process the contents of the compensated fuel tanks on the DDG-51 class destroyer (500,000 gallons). They use the holding tank to allow for some phase separation of the mixture and then process it through activated carbon filters. The total cost to Bath Iron Works for this operation is approximately \$50,000.

J.D. Meagher of Massachusetts was also queried. Meagher uses a two stage process consisting of a coalescing plate tank to reduce the free oil concentration to 40 ppm and then bag filters to reduce the concentration to 1 ppm. The anticipated flow rate of this process is 500 gpm. If the 500 gpm flow rate is obtained and maintained the total cost of treatment would be \$13,000. If the flow rate is less, the cost will increase as the equipment is on a time rental.

---

<sup>2</sup> At this stage of the project, other methods are evaluated.

<sup>3</sup> Companies supplying information for section are listed in Appendix E

This system would not treat emulsified oil. To do so would require a dissolved air flotation (DAF) system or a precipitate tank to get the emulsified oil out. Cost would depend on the amount of emulsified oil and how difficult it is to remove with their equipment.

## 2.2 Oil/Water Separators

Oil/Water Separators are very common in the marine industry. Most large ships have at least one to clean their bilge and oily water before discharge over the side. These pieces of equipment operate with brushes or perforated plates that encourage the oil to raise to the surface and the clean water is siphoned off of the bottom.

Three manufacturers were contacted. Their most effective systems are outlined in Table I.

Manufacturer	Flow Rate	LxWxH (ft)	Weight (lbs)	Cost
Blohm & Voss	47 gpm	4.5x4.5x4.1	5,300	\$20,000
Hyde	100 gpm	20x6x5	42,770	\$30,000
Microphor	44 gpm	5.1x4.2x6.4	4,300	N/A

**Table I. Oil/Water Separators**

None of these systems provide the needed flow rate of 500 gpm. All of the above systems clean the waste water to within 10 to 15 ppm. Because of this shortfall, an additional unit to polish the water is necessary. This is because the oil concentration must be less than 10 ppm and because without additional treatment a 10 ppm solution will produce an oily sheen. All of the above systems are trailer mountable for movement between shipyards.

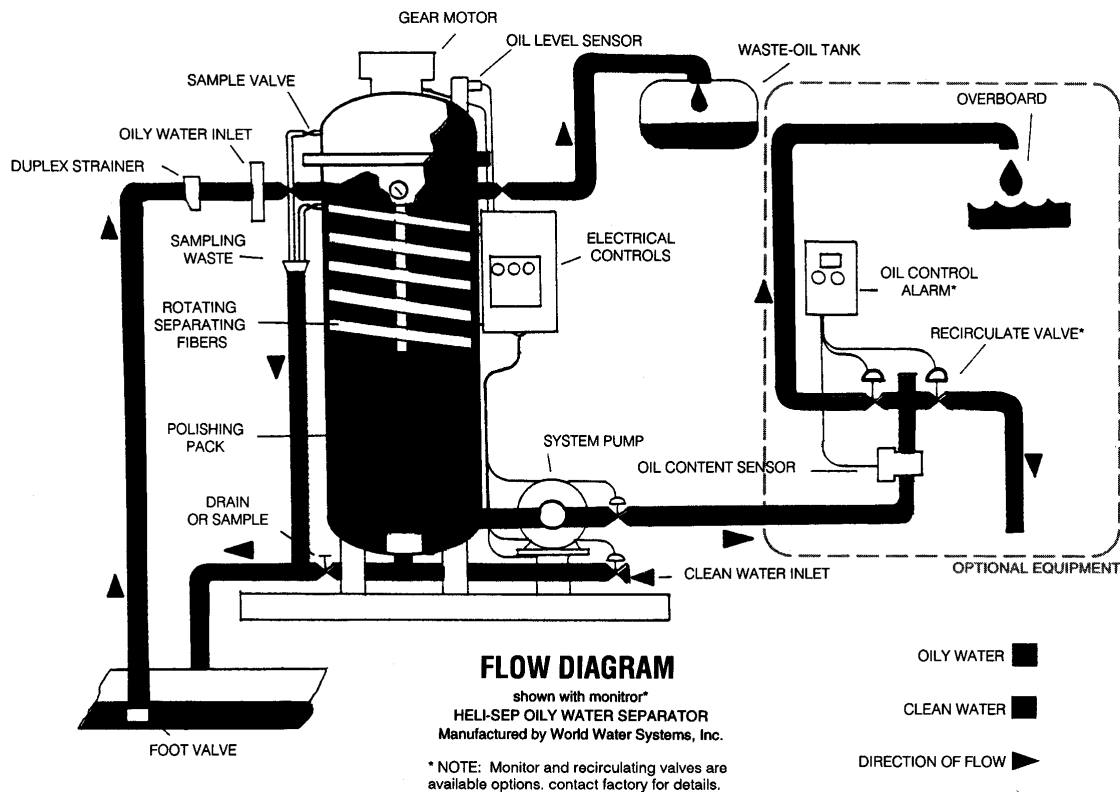

**Figure 1. Sample Oil/Water Separator**

### 2.3 Membranes

Membranes operate by creating an osmotic pressure gradient between the waste water and clean water. The membrane then selectively allows substances to cross it leaving the oil on the inside the of membrane and the clean water outside. Advancements have been made which keep the oil from fouling the cellulose fibers of the membrane, and membranes have been used for both batch processing of water and for continuous process streams. Separation Dynamics Incorporated (SDI), a leader in membrane technology, was contacted and their systems were examined.

Manufacturer	Flow Rate	Cost
Separation Dynamics Inc.	35-50 gpm	\$100,000-\$200,000
Filtration/Treatment Systems	70-0150 gpm	\$100,000-\$300,000

**Table II. Membranes**

This system does not have the required flow rate either, but it will treat emulsified oil. SDI is undertaking a large research and development project to improve their membrane performance for marine applications. The existing membrane systems have questionable reliability. Some units will work for years without failure, others just days. As a result, until the research and development project is completed no more membrane systems are being sold. This system was available either skid mounted or trailer mounted.

### 2.4 Coalescing Tanks

Coalescing tanks are fitted with internal plates that are oleophilic (oil attracting) and are normally constructed from polypropylene or poly-vinyl chloride (PVC) and set at an angle to the liquid flow. The tanks are normally fiberglass or epoxy coated steel to reduce corrosion. The oil and water pass over these corrugated plates and the oil droplets combine into large droplets. The larger the droplet the faster it will rise, as described by Stoke's Law. The oil is collected in a weir at the top. Solids fall out of solution because of the changes in velocity as the water flows over the corrugations and are collected at the bottom.

Four distributors of tanks of this design were contacted. Their most applicable designs are listed in Table III. All of the systems purify free oil to 10 ppm or less.

Manufacturer	Flow Rate	LxWxH (ft)	Weight (lbs)	Cost
Apollo	500 gpm	24x6.5x7	18,000	\$280,000
Great Lakes Environmental	500 gpm	14x8.9x7.3	9,200	\$36,000
Highland Tank	600 gpm	28.6x6x7	9,485	\$24,000
Monarch	500 gpm	N/A	N/A	\$28,000
Hydro-Flo Technologies	500 gpm	15x8x7	9,040	\$34,500
Filtration/Treatment Systems	500 gpm	16x11x7	15,000	\$48,500

**Table III. Coalescing Tanks**

The coalescing tanks above provide the required flow rate and reduce the effluent to the required oil concentrations. Additional polishing equipment is required to remove the oily sheen or emulsified oil.

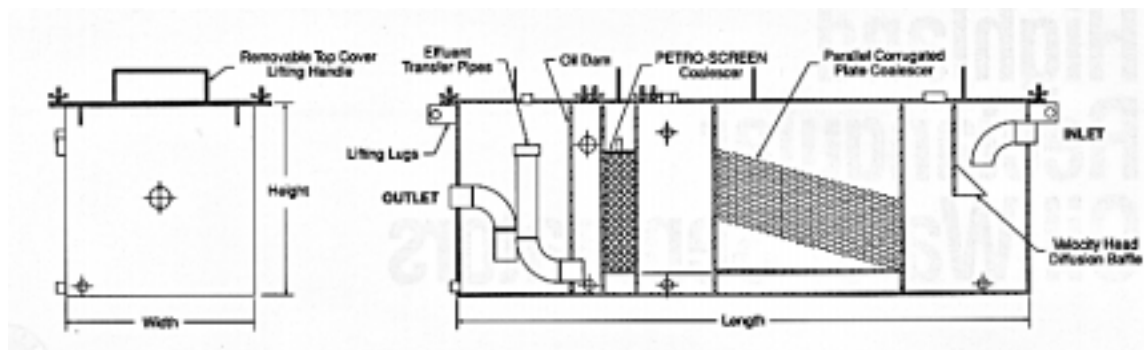

**Figure 2. Sample Coalescing Tank**

### 2.5 Dissolved Air Flotation (DAF)

This technology is commonly used on offshore oil drilling platforms. These systems use a combination of Stoke's Law, Henry's Law, and Nucleus Theory. The principle of operation is that air is dissolved into the oily water while it is under pressure. The pressure is then removed from the water and the dissolved air comes out of solution. This is Henry's Law. It can be easily observed in everyday life when a bottle of soda is opened. The pressure inside of the bottle is reduced when it is opened and the carbonation forms bubbles. As in a bottle of soda, the bubbles rise to the surface and the larger they are the faster they rise. This is Stoke's Law. As these bubbles of air rise they collide with, and attach to, the suspended oil and in turn carry it to the surface. This is nucleus theory.

Three distributors of this kind of equipment were contacted. A listing of their best suited equipment is below. To handle the waste stream for this project, a full system consists of a coalescing tank similar to the one described above with the DAF unit attached downstream of it. Full system capabilities and arrangements vary.

Manufacturer	Flow Rate	LxWxH (ft)	Weight (lbs)	Cost
Jalbert and Assoc.	100 gpm	24x8.5x7	N/A	N/A
Hydro-Flo Technologies	100 gpm	26x7x10	11,000	\$53,000
Filtration/Treatment Systems	100 gpm	12x6x8	10,000	\$90,000

**Table IV. Dissolved Air Flotation**

### 2.6 Polishing

The technologies described above purify the water to the point that it complies with the 10 ppm limit. However, they do not necessarily remove the potential for a sheen to be created. The sheen will rise to the surface even if the oil concentration is 5 ppm because the differences in specific gravity accelerate the separation any remaining free oil. To solve this problem the effluent is commonly run through another polishing filter. These filters can come in a variety of forms.

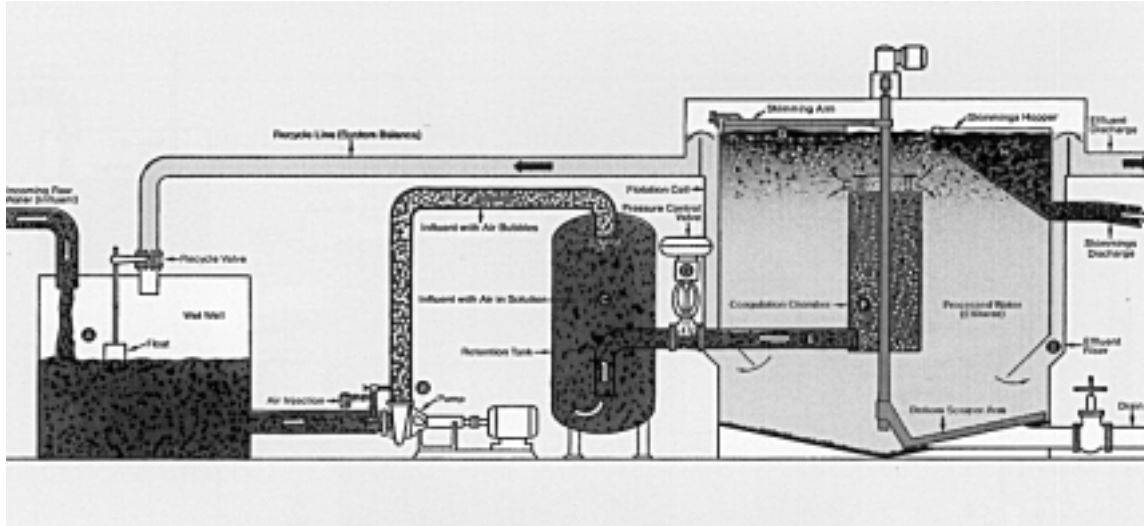

**Figure 3. Sample DAF System**

**2.6.1 Activated Carbon**

Activated carbon is used to polish water because its highly porous surface collects oil and suspended solids. The waste water is run through a bed of granular carbon either at atmospheric pressure or with a pressure gradient applied. The carbon absorbs the oil but will eventually reach capacity. Additional life can be given to the carbon bed by reversing the flow and washing the oil out. This however is only a temporary solution. The activated carbon will eventually become spent and need to be replaced. The disposal of the spent carbon presents a significant cost because once it is contaminated it is classified as a hazardous material and must be disposed of as such. The activated carbon bed can be quickly ruined if a slug of very oily water passes through the system.

**2.6.2 Clay**

Great Lakes Environmental produces a clay filter that is claimed to be seven times more effective than activated carbon. It once again operates on the same principles and has the same drawbacks. One additional advantage is that it is compact enough to be trailer-mounted.

The sheen can also be removed once the effluent has been discharged. The effluent can be discharged into an isolated, specified area that is contained by an oil absorbent boom.

Some shipyards are located in municipalities that have very capable public works. In these cases the public works can dispose of small concentrations of oil and the sheen. Four sewer system operations were contacted. The cost of disposal of the water into the sewer cannot be determined at this time because it is dependent on the total monthly average volume of water discharged by a given shipyard.

<b>Location</b>	<b>Oil Accepted</b>	<b>Zinc Accepted</b>
Ann Arbor, MI	0 mg/L	2 mg/L
Bath, ME	100 mg/L	1 mg/L
Hampton Roads, VA	50 mg/L	1 mg/L
San Diego, CA	500 mg/L	2 mg/L

**Table V. Sewer Systems**

Although the city of Bath accepts oily water, it does not accept oily saltwater because the chlorides present will kill the biological organism it uses in its treatment process. The above sampling of sewer systems indicates that some yards may be able to use the local sewer system to polish their waste water instead of using an additional activated carbon or other unit. The economics and operational difficulties of this must be examined. The cost per gallon of water discharged into the sewer system may be such that the capital outlay for an additional polishing unit is the more economic choice. Also, the infrastructure of the yard must be able to support an additional 500 gpm sewage flow. If the piping in the yard is not large enough, either new pipe must be laid or other water discharging operations must be halted while deballasting is underway. If the local municipality is relied on for processing, the shipyard is also vulnerable to stricter discharge laws that may be applied in the future.

### **3.0 Summary**

From the above tables it can be seen that for membranes and oily water separators to compete with coalescing tanks at the preferred flow rates, multiple units must be operated in parallel. Since the acquisition costs for membranes and oily/water separators is fairly high, purchasing multiple systems for the required flow rate cannot compete with a single coalescing tank that costs approximately \$30,000. However, the recommendation to purchase coalescing tanks cannot be made at this time because more information is needed on DAF equipment and on the nature of the waste water stream.

Polishing systems cannot be recommended at this time because good comparative cost data is not available. Additionally, the actual performance of polishing systems should be directly observed handling a representative waste stream. This is because polishing is the last line of defense the shipyard has against a possible “spill,” even though it is a minimal sheen. If at any time the polishing system did not perform up to the specifications of the design, a polluting discharge could occur resulting in Environmental Protection Agency (EPA) or U.S. Coast Guard action.

Additional research will be documented in Phase II of the report. This will include additional information on:

- DAF technology
- Polishing techniques
- The operating characteristics of all 12 shipyards
- The sewer systems surrounding all 12 shipyards
- Trailing costs
- Any future amendments to the Clean Water Act

### **Conclusion**

Data has been gathered on the theoretical aspects and actual performance of treatment systems for waste water by oil/water separators, membranes, dissolved air flotation, coalescing tanks, and sewer systems. Membranes and oily/water separators are not competitive with coalescing tanks and DAFs because of cost and size for the flow required. During Phase II these gaps will be filled, vendor claims will be verified through on-site inspections, and recommendations for a waste water treatment system(s) will be made.



## **APPENDIX B**

# **LITERATURE SEARCH RESULTS**

## Bibliography

Kura, Bhasker. Knecht, Albert T. McManis, Kenneth. and Lea, W. Reid. Environmental Compliance by Japanese Standards. SNAME 1996 Ship Production Symposium, San Diego CA

Strickland, James K. Lancaster, John B. Bildgewater Processing Prototype Unit

Reduction of Toxicant Pollution from the Maritime Industry in Puget Sound. Industrial Waste Program Water Pollution Control Department. March 1992

Annual Report, Urban Waste Management and Research Center. University of New Orleans. 1993-1994.

Larson, Roy. Taylor, John. A Diffusion Membrane for Separation of Hydrocarbons from Water Streams. The Membrane Conference on Technology/Planning. November 1991

Taylor, John, Larson, Roy. Scherer, Billy. Treatment of Offshore Produced Water: An Effective Membrane Process. Environment Northern Seas International Conference and Exhibition. August 1991

Separation Dynamics International. Description of SDI Membrane Technology, June 1992

Separation Dynamics International. A New Membrane Process for Separations in Oily Water Streams. The Membrane Conference of Technology/Planning. October 1992

City of Ann Arbor. City of Ann Arbor Sewer Use Ordinance, Chapter 28 of Title II of the Code of the City of Ann Arbor. October 1994

Lancaster, Fredrick A. Roberts David S. Ganni H. and Brezovec, Paul. Waste Water Recovery and Refuse Technologies for Industrial Metal Products and Machinery Operations. SNAME 1996 Ship Production Symposium. Feb 1996

West Virginia Pulp and Paper Company. Study of Powderer Carbons for Waste Water Treatment and Methods for Their Application. September 1969

Gutman, R.G. Membrane Filtration, The Technology of Pressure-Driven Crossflow Processes. Adam Hilger, Bristol. 1987

Edwards, Marc. and Ryan, Joseph. Critical Issues in Water and Wastewater Treatment. Proceedings of the 1994 National Conference on Environmental Engineering. July, 1994.

Carbon Column Operation in Waste Water Treatment. Syracuse University, NY. Nov. 1970

Garland, C. F. and Beebe, R. L. Advanced Wastewater Treatment Using Powdered Activated Carbon in Recirculating Slurry Contactor-Clarifiers. Federal Water Quality Administration, July 1970

Fressenius, W. and Schneider W. Waste Waster Technology, Orgin, Collection, Treatment and Analysis of Waste Water. Springer-Verlag, New York, 1989

Beychok, Milton Aqueous Wastes from Petroleum and Petrochemical Plants. John Wiley and Sons, New York, 1973.

Purchas, Derek B. Industrial Filtration of Liquids. CRC Press, Cleveland, OH. 1971

Vigneswaran, Saravanamuthu. Water, Wastewater, and Sludge Filtration. CRC Press, Boca Raton, FL, 1989

DDG 51 Class Ships Fuel Oil General Familiarization Student Guide. Bath Iron Works Corporation.

## **APPENDIX C**

### **FILTRATION TREATMENT SYSTEMS**

### **TREATMENT METHODS ANALYSES**

# COMPENSATED FUEL BALLAST WATER TREATMENT

Jeffrey D. Pettey .<sup>1</sup>

## INTRODUCTION

Shipyards are working hard to reduce their environmental water discharges and the associated impacts on the local surroundings. Note that the term ‘environmental water discharges’ was used. Any wastewater discharged under a NPDES permit, whether it be industrial or storm water, must be returned back to an acceptable environmental quality, regardless of background.

In the future, likely circumstances for wastewater processing are that:

- Hazardous waste will be reprocessed and/or repackaged for partial or full reuse;
- Environmental discharges, whether they are industrial or storm water, will be cleaner than that of the local surroundings;
- Regional water providers will look at discharging enhanced treated municipal wastewater streams into rivers, lakes, and estuaries in order to provide a water balance for pumping drinking water out of the same water body (the water balance is necessary for fish, birds, and other endangered species continuously added to a growing list);
- The enhanced wastewater treatment process may require tighter industrial discharges into the publicly owned treatment works (POTW);
- Public awareness may force even tighter restrictions on National Pollutant Discharge Elimination System (NPDES) discharges in local water bodies that are being used for a drinking water supply; and
- It will be cost effective for shipyards to reuse a significant portion of the wastewater in lieu of discharging under a NPDES permit.

With this in mind, development of a unique system for treating ballast water from compensated fuel tank ships was initiated.

## GOALS AND OBJECTIVE

The main design benefit of compensated fuel tanks are that they streamline and minimize the overall ship size and allow the ship to maintain a consistent draft. By combining the ballast water tank with the fuel tank, the fuel which is lighter than water floats on top of the ballast water. This eliminates the extra tank needed to balance the loss of fuel during extended ocean transits. Although careful design standards are used to minimize the mechanical emulsion of the fuel into the ballast, there is a zone of which both products are mixed together.

This is a design disadvantage. Although careful fueling of the ships accounts for the location of the mixed product zone in relation to ballast water discharge, all the ballast water, including the mixed product zone, must be discharged prior to tank inspection and repair at a shipyard. The disadvantage is the need for quick removal and processing of the contaminated portion of the compensated fuel ballast water prior to discharging this water back into the environment.

---

<sup>1</sup> President/Founder/Director, Filtration/Treatment Systems, Ltd., Advanced Environmental Solutions, Inc. 7118 South 220<sup>th</sup> Street, Kent, Washington 98032, Phone: 253-872-9007, email: [www.filtreat.com](http://www.filtreat.com) or [ftsas@wolfenet.com](mailto:ftsas@wolfenet.com). edited by Albert W. Horsmon, Jr., UMTRI

The desired objective is to strip the ballast water of its environmental contaminants efficiently and consistently prior to discharging under a NPDES permit. This particular process design is preferred towards being mobile and requiring minimal operator attention. This will allow multiple shipyards to utilize the same treatment process with minimal training requirements.

## **BACKGROUND**

Previous assumptions must be revisited to evaluate whether they apply. As the discharge guidelines get increasingly tighter and new ship design and repair techniques develop; new sources of contaminate generation will need to be identified and evaluated. This generation needs to be studied for elimination through product or process substitution, treatment at the point of generation, or treatment at the end of pipe. Before specifying any treatment process, a thorough analysis of the application and its options must be made.

The compensated fuel ballast tank design is a case in point. It was recently introduced into ship design. However along with this ballast tank design, the ship has developed a new source for stream contamination.

## **RELEVANT TECHNOLOGIES**

A brief review the relevant treatment technologies is in order to study their strengths and weaknesses with certain applications.

### **Skimmers**

If there is enough petroleum product rising to the top of the water level, air is sealed away from interfacing with the water volume. This, in turn, allows for the anaerobic bacteria to start feeding and thriving within the non-air environment. In time, the contents within the tank will go septic, acidify, and smell like rotten eggs.

The free petroleum layer on top of the water level will always need to be removed in order to minimize the development of the anaerobic bacteria. There are a wide variety of skimmers on the market that can accomplish this process need.

**Floating Suction** - This type of skimmer typically floats on top of the water column. Its floating suction can be adjusted for skimming only petroleum products or for providing for pump discharge of the tank contents from the top down. The later arrangement is recommended since this type of process will continually remove the top clarified layers into the next process. This next process must have the ability to take 100% petroleum product and still produce a clear effluent. The former process is not recommended for it could potentially lend itself to establishing an anaerobic population since an oil layer will always be developing for skimming.

**Feathered Rope** - This type of skimmer is perfect for emergency spills. It offers a substantial amount of surface area per unit length of skimmer. Therefore, it can pick up a lot of product in a short amount of time. But its continual usage is very limited. The majority of absorption surface areas are lost due to increased matting over time. Replacement costs are high.

**Tube Type** - An oleophilic tube skims along the water surface before returning back to the drive unit where both sides get lightly scraped of their oil content. It works well with limited maintenance and replacement. It does need a large amount of surface area to be efficient.

**Belt Type** - An oleophilic belt drops down into the water and returns up - picking up any attached oil. The drive unit also scrapes both sides of their oil content. It works well with limited

maintenance and replacement. It is not as efficient as the tube type in removing large amounts of petroleum product; but, only needs a small surface area to be efficient.

**Disk Type** - This type of skimmer is an oleophilic wheel which rotates halfway immersed in the water. The drive unit also scrapes the oil off both sides. It works well with limited maintenance and replacement. It can not be used in applications where the tank water level varies.

### **Oil/Water Coalescing Separators**

Generally speaking, only oil droplets of a minimum size of 150 microns or greater can have a sufficient amount of buoyancy to rise through a water column to the surface. The American Petroleum Institute (API) has classified oil into 5 classes. They are:

1. **Free Oil** - Oil droplets of 150 microns in diameter or more.
2. **Dispersed Oil** - Oil droplets from 20 - 150 microns in diameter.
3. **Mechanically Emulsified Oil** - Oil droplets that are less than 20 microns in diameter primarily due to some sort of mechanical shear force (i.e.: mixing/pumping - compressor blowdown).
4. **Chemically Emulsified Oil** - Oil droplets that are less than 20 microns in diameter primarily due to some sort of chemical bonding (i.e.: surfactants/cleaners).
5. **Stable Emulsion/Dissolved Oil** - Oil that is in solution with its carrier (i.e.: machine coolants).

The greatest achievement in oil/water separation was in the application of coalescing media for enhanced separation. The coalescing media is made of an oleophilic material which has a greater attraction for petroleum products than water does. If the petroleum product touches the coalescing surface while traveling through the media pack, it sticks and gather amongst the other oil droplets. Eventually, through extended contact, the gathered oil droplets coalesce into larger droplets. Once the proper oil droplet size is achieved, the oil separates from the media pack and rises to the top of the water column for skimming and/or decanting.

An important design feature for coalescing media packs is that they are of a slant rib corrugated design. This allows for both the free floating oils and the settled solids to stratify cleanly without plugging the media. There are other non- slant rib designs available but they plug up readily. API has published a standard (API Publication #421) for properly sizing coalescing media depending on:

- Specific Gravity of Petroleum Products - 0.96 maximum
- Process Stream Temperature
- Oil Droplet Size Needed To Be Removed - 20 microns minimum
- Effluent Quality Needed To Be Achieved - 10 ppm minimum

### **Centrifuges**

Centrifuge technologies come in two phase or three phase separation designs. They lend themselves to automation while taking up a relatively small area. This type of processing is generally best used for bulk removal, sticky sludge dewatering, or steady state separation. Centrifuges can be used for polishing; but this typically will increase the residence time required for removal. This will also increase the size and its relative cost. There are separation types are Liquid/Solid, Liquid/Liquid, and Liquid/Liquid/Solid. They are most competitive where space minimization and/or automation is required.

**Liquid/Solid** - A basket centrifuge forces solids to take the outside track due to g forces. The pool of liquid is clarified and overflows the inner track to the centrate outlet. The accumulated solids continue to build until the centrifuge goes off-line and scrapes itself out of the solids sludge. Another viable type of liquid/slurry separation is cyclone separation. It is very inexpensive and fairly efficient when processing a water stream laden with heavy, non-sticky solids.

**Liquid/Liquid** - This style of centrifuge is typically used for bulk oil/water separation and/or fuel purification. It typically has very tight space requirements and runs continuously with no downtime. If solids are present, they will follow the heavy phase liquid.

**Liquid/Liquid/Solid** - Actually this design is a combination of both the prior two. The two liquid phases are continually separated with the centrifuge going off-line to plow out its accumulated solids.

## **Air Flotation**

There are two primary technologies which use air bubbles for contaminate removal. The air bubbles are randomly fitted and attached to the suspended particulates and oils. Much like air bags are used for underwater recovery, the air bubbles provide the buoyancy and lift for the contaminants to float to the top of the tank for skimming. It is the generation of the air bubbles that differentiates the technologies.

**Induced Air Flotation (IAF)** educes air into the bottom of the water column. The bubbles are generally sized at 35 - 45 microns. The best IAF design attributes are that the process is very simple, requires little space, and is generally self sufficient.

**Dissolved Air Flotation (DAF)** takes a portion of water effluent and returns it to a repressurization column. Pressurized air (80 psi) is saturated into the water effluent stream before this water is combined with the incoming untreated water. Once the combined water stream enters into the atmospheric flotation tank, the dissolved air comes out of solution and into 25 micron air bubbles.

It is the size of these bubbles that make the DAF process more efficient in removing the contaminants. One can attach more air bubbles to the contaminant for flotation. However, there is more equipment, space and process knowledge needed to make this treatment technique work. Differences in the types of effluents being processed determine whether IAF or DAF can be successfully applied.

## **Membranes**

Membrane technology is one of the fastest growing in application development in this industry. The types and variations of membranes are growing as market awareness finds acceptable solutions to use them cost effectively. There are four different type of membranes.

**Micro Filtration** - Micro filtration removes particles down to 0.1 micron. It is primarily used in aqueous cleaning bath recovery and suspended solids purification.

**Ultra Filtration** - Ultra filtration removes particles down to 0.005 microns or 10,000 MW (molecular weight). It is primarily used in emulsified oily wastewater purification (POTW).

**Nano Filtration** - Nano filtration removes particles down to 150 MW. It is primarily used in reduction of hardness, color and total dissolved solids, water recycling, and emulsified oily wastewater purification (NPDES).



**Hyper Filtration (Reverse Osmosis)** - Hyper filtration removes items down to 97%-99.5% specific ion rejection. It is primarily used in ultra pure water purification, water recycling, and sea water desalination.

Most process designers use reverse osmosis exclusively - generally due to being unaware of the other membrane technologies. Nano filtration shows the most promise for wastewater application. It is generally less than one half the pressure requirement than that of reverse osmosis. It is known for its anti-fouling characteristics which makes it work well in high scaling environments.

For highly contaminated process streams, the ultra filtration membrane has a tubular configuration which allows for suspended solids and free oils to pass through cleanly. This allows for increased concentration of the contaminants without damaging the membrane surfaces.

There is one general rule for extended membrane use: one must never leave a membrane dirty or in a drying state after the process is taken off line. Before a subsequent start-up, the leftover filtrate will need to be scraped off. Access for scraping scale or other deposits off of membrane skins is difficult.

Membrane systems designed with an automated permeate flushing process make the cleaning process much easier. This process immediately rinses the membranes with clean permeate stored on the skid. The rinsing is done every time the membrane goes off line. For difficult applications, a periodic fast flushing stage can be added to the processing cycle which automatically increases the amount of flow going through the membrane for flushing out any accumulated solid or gel layers.

### **Absorbents**

An efficient processing philosophy is one which minimizes consumables to a point where they are used solely for polishing processes. They play an important part in providing additional assurance of effluent quality or protecting other processes from being contaminated. However, their replacement costs are expensive in comparison to the actual amount of contaminant they remove. In addition, they must be disposed of as oily or hazardous waste.

For example, a large aircraft manufacturing plant acquired a cartridge filter system for purifying their centralized machine oil used in grinding and cutting operations. They expected to get 35 - 40 days of use before exchanging cartridges. Sixteen hours after start up, the first cartridge change was required at a total cost of \$2,500. Suddenly, a \$275,000 centrifuge with no replacement costs became economically viable

**Activated Carbon (AC)** - Activated carbon has been widely used in many types of petroleum contaminated water streams. Its best efficiency is when used for absorbing light phase organics such as gasolines and solvents. The heavy phase organics such as oils and diesel fuel encapsulate the AC instead of being absorbed into its matrix. The reduction of activated sites available for absorption can be reduced to 8 - 10% of the maximum potential due to the heavy phase encapsulation.

**Bentonite Clay with Additives (BCA)** - Bentonite clay has been used recently for removing heavy phase organics. The clay is typically mixed with anthracite (a filter aid) in a 30/70 ratio. The clay provides the absorption sites where the anthracite provides the porosity. Some clay products add a cation additive in order to remove a very limited amount of dissolved metals and earth salts. The largest problem is that some clay products do not have enough filter aid and have a propensity to set up like moist cement. This makes removal difficult and time-consuming.

In mixed organic streams, BCA is often used in front of AC for absorption of the heavy phase organics. This increases the AC life by 10 to 14 times that of using AC alone.

**Polymerized Absorbents** - Polymerized absorbents are the recent technology in this market. The polymer absorbents are designed for absorbing and solidifying the petroleum product within its matrix. Much like BCA, filter aid additives are used to increase the porosity. This product typically reduces the amount of contact time needed for absorption and can be applied amongst a wide range of petroleum products and concentrations.

## **PROJECT DESIGN GUIDELINES**

For multiple shipyards to use a mobile treatment technology, design parameters must be established to meet the physical, process, and personnel limitations expected. These guidelines will push certain technologies to be needed for this process. These parameters are listed below.

**Usable in Multiple Locations** - Since this process is specific to a particular wastewater stream, the treatment system needs to move to different locations where the compensated fuel tanks vessels are being worked on. Otherwise, a stationary treatment system will need to address a wider amount of wastewater streams in order to be cost efficient to the end user.

**Easy to Operate and Troubleshoot** - Whether the treatment process is being used in multiple locations or in one; shipyards do not want to create a full time technical position just for maintaining the process. With a minimum amount of training, a person of average capability should be able to run and maintain the process as a small part of their daily responsibilities.

**Ability to Take In Varying Contaminate Loads** - The shipyards can not control what is actually coming off the ship. All they can do is make the proper connections and pump out. They do not generate this waste. The ships do. But the shipyards need a process system that can handle varying concentrations of contaminant loading and still produce a quality effluent.

**Compact Physical Design** - Some shipyards are located in prime real estate areas. As their business grows, their area of operations get more creative and selective in space utilization. They need a treatment process that will do the job right and is sized right for their space limitations.

**Reasonably Large Process Flow** - For a mobile treatment operation, a shipyard needs to get the ballast water treated and off the waterfront so as to allow for other repair operations to begin. A reasonably large process flow is required for being able to open up workspace. A stationary plant with a large equalization tank could be sized substantially smaller and located in a more remote area of the shipyard.

**Heavy Industrial Duty Construction** - The equipment design must be matched to the environment. A working shipyard environment is rough on equipment. The equipment must be of heavy industrial duty construction to withstand the test of time.

### **A Mobile Option**

Oily ballast water enters the Receiving Tank to await processing. The non-emulsifying feed pumps transfer the oily ballast water to the liquid/liquid centrifuge for separation. The Liquid/Liquid Centrifuge separates the oily ballast water into two separate process streams. The waste oil stream is directed to a waste oil storage tank while the contaminated water flows into the equalization clearwell.

From this clearwell, the contaminated water is transferred to the Induced Air Flotation process. The influent water is chemically pretreated to enhance the Induced Air separation process. The

contaminant particles which naturally repel one another are chemically compelled to combine as precipitate in the water stream. Air is educed into the water stream where the bubble attaches to fine particulates. These particulates with the air bubbles will rise to the surface and create a floating scum layer. This layer is periodically skimmed off and into the float collection tank. The float is eventually transferred to the float sludge tank. Heavier sludge collects in the sludge hoppers at the bottom of the unit and is transferred directly to the float sludge tank.

The remaining water is transferred to the polymerized absorbent polish for further treatment. The water flows through a polymerized absorbent media and is cleaned of the residual petroleum products.

### **A Stationary Option**

A stationary treatment process needs to be able to address a wider set of wastewater streams. Oily ballast and other brackish water are pumped to the Equalization Sump Tank where they can initially stratify into layers. The Oil Skimmer Assembly removes the top layer from the oily wastewater and pumps it to the Oil/Water Separator. Further skimming of the tank surface will prevent an anaerobic bacterial environment and optimize further processing.

Upon entry into the separator, the free oil separates immediately from the stream and float to the top of separator. Heavy suspended solids will settle down by the sludge outlet to final processing/disposition elsewhere. The wastewater with the smaller oil droplets will enter into the coalescing media. The droplets will stick to the media, combine to form larger droplets, and eventually become buoyant enough to rise to the top of the water column. The accumulated oils are decanted and removed via the oil outlet.

The water effluent will be still lightly contaminated with either emulsified and soluble oils. The wastewater is transferred to the Dual Quad Multimedia Solids Filters. Overflow from the Oil/Water Separator is transferred to the Equalization Sump Tank and ultimately returned for retreatment. Bottom entry of the overflow into the Equalization Sump Tank reduces vapor emissions and aids in re-stratification.

The Multimedia Filters remove iron, sediment, debris, and other macro particles contained in the stream. Removal of these particles also enhances the performance of the Nano Filtration System. The Multimedia Filters are periodically backwashed of debris using process water that is returned to the process for pretreatment.

The stream enters the Nano Filtration System where dissolved solids from sources such as sea water, storm water, and city water are removed. The Nano Filter Concentrate is returned to an overflow tank where it is fed into the Equalization Sump Tank for reprocessing. The Nano Filter Permeate enters the Clean Effluent Tank where it will be environmentally discharged at safe limits.

### **Basic Recommendations**

- Stationary treatment plants are needed for ongoing daily/weekly needs. For infrequent needs, a specific mobile treatment plant can be cost justified by multiple users.
- The shipyard can quickly treat the compensated water to an environmental background purity and reuse the fuels without permanently giving up valuable dock space.
- Thorough field pilot testing is needed to establish the process integrity.
- Partial scale pilot testing is recommended for each of the sites prior to bringing the mobile treatment plant into the shipyard.

## **APPENDIX D**

### **TREATMENT SYSTEM DESCRIPTIONS**

Mobile One Trailer System, Filtration/Treatment Systems, Ltd.....	D-1
Jalbert Two Unit Portable 400 GPM System. ....	D-3
Hydro-Flo 100 GPM System With Storage.....	D-5

## **MOBILE WASTEWATER TREATMENT TECHNOLOGY**

Filtration/Treatment Systems, Ltd.  
Advanced Environmental Solutions, Inc.  
7118 South 220<sup>th</sup> Street, Kent, Washington 98032

253-872-9007 phone & 253-872-9004 fax  
www.filtreat.com or ftsaes@wolfenet.com

Oily ballast water enters the Receiving Tank to await processing. The non-emulsifying feed pumps transfer the oily ballast water to the liquid/liquid centrifuge for separation. The Liquid/Liquid Centrifuge separates the oily ballast water into two separate process streams. The waste oil stream is directed to a waste oil storage tank while the contaminated water flows into the equalization clearwell.

From this clearwell, the contaminated water is transferred to the Induced Air Flotation process. The influent water is chemically pretreated to enhance the Induced Air separation process. The contaminant particles which naturally repel one another are chemically compelled to combine as precipitate in the water stream. Air is educed into the water stream where the bubble attaches to fine particulates. These particulates with the air bubbles will rise to the surface and create a floating scum layer. This layer is periodically skimmed off and into the float collection tank. The float is eventually transferred to the float sludge tank. Heavier sludge collects in the sludge hoppers at the bottom of the unit and is transferred directly to the float sludge tank.

The remaining water is transferred to the polymerized absorbent polish for further treatment. The water flows through a polymerized absorbent media and is cleaned of any residual petroleum products.

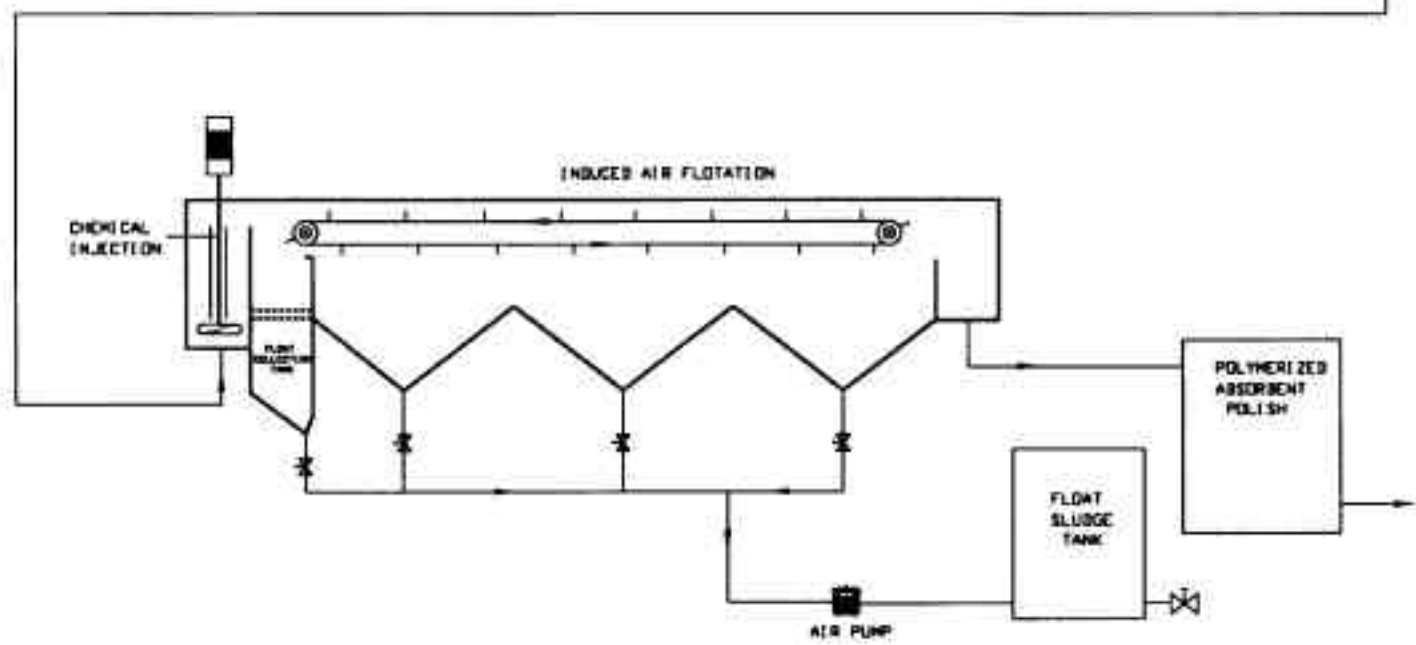
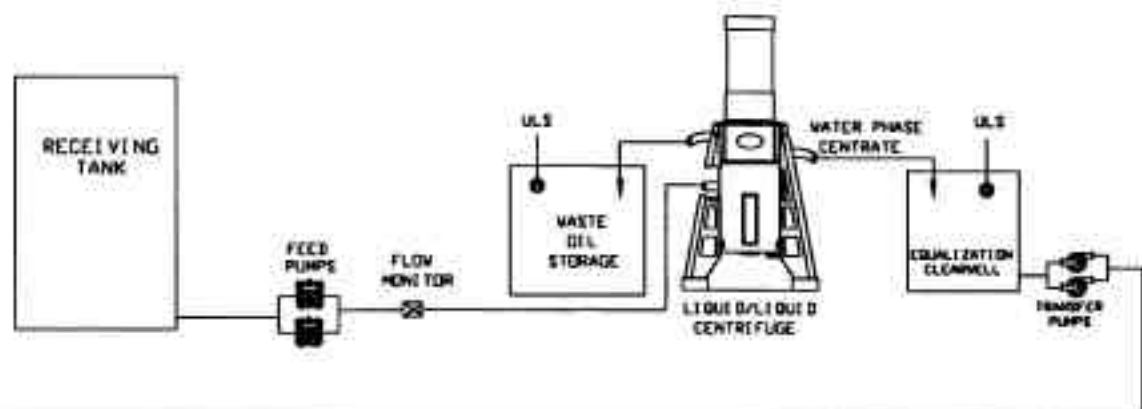

— SYSTEM SPECIFICATIONS —

FLOW RATE	
WATER	
TEMPERATURE	
ELECTRICAL	
REF	DESCRIPTION

PROPERTY OF:  
**FILTRATION/TREATMENT SYSTEMS LTD.**  
THIS DRAWING AND ALL INFORMATION HEREON IS THE PROPERTY OF FILTRATION/TREATMENT SYSTEMS LTD. AND IS CONFIDENTIAL AND NOT TO BE MADE PUBLIC OR COPIED. THIS DRAWING IS LOANED SUBJECT TO RETURN UPON DEMAND AND IS NOT TO BE USED IN WHOLE OR IN PART FOR ANY OTHER PROJECT, TO BE REPRODUCED.

**FILTRATION/TREATMENT SYSTEMS LTD.**  
 7118 S. 220th STREET  
 KENT, WA USA 98032  
 PHONE (206)872-9007  
 FAX (206)872-9004

DRAWING NO.: NONE  
 DATE: 7/87  
 DRAWN BY: VLADJ  
 CHECKED: JUNE YI  
 DESIGNED BY:  
 APPROVED:

COMPENSATED BALLAST WATER TREATMENT SYSTEM  
 FOR  
**UNIVERSITY OF MICHIGAN**  
 TRANSPORTATION RESEARCH INSTITUTE



**JALBERT ENVIRONMENTAL, INC.**

2848 CRUSADER CIRCLE  
VIRGINIA BEACH, VA 23456  
TEL. 757-468-2747  
FAX 757-468-8442

Date: July 18, 1997 Pages: 2

Attention: Al Horsmon / Tanya Mulholland  
University of Michigan  
Transportation Research Institute, Marine Systems Division  
Fax 313-936-1081  
Tel. 313-764-5308

From: Perry Mann

Subject: Trailer mounted DAF systems for bilge water treatment

We have enclosed a preliminary Dissolved Air Flotation system design drawing that would easily flow your process fluid at 400 gpm. The system could possibly be run at its maximum hydraulic loading of 500 gpm, but that would be dependent on each particular waste stream. The system's overall height would be approximately 9 ft. without any hand rails or skimmer drives mounted on the top bridge assembly. The overall width would be 8 ft. The systems would be essentially be two independent duplex 200 gpm DAF systems.

The budget price for the DAF system installed and tested on two customer supplied trailers is \$ 250,000.00 to \$ 275,000.00.

The only items not shown on the system or are not included in the budget price are the trailers, influent pumps, effluent pumps (if required), air supply and the bulk (free) oil removal (detection) system.

If you have any further questions or comments we will try our best to help.

Regards,

Perry Mann  
Engineering Manager

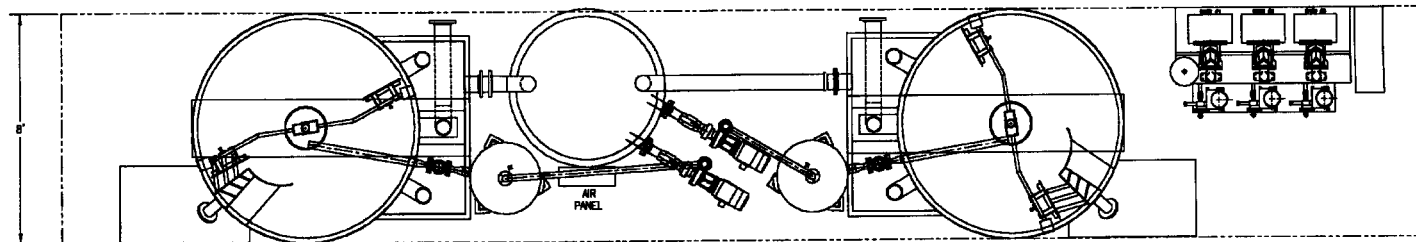
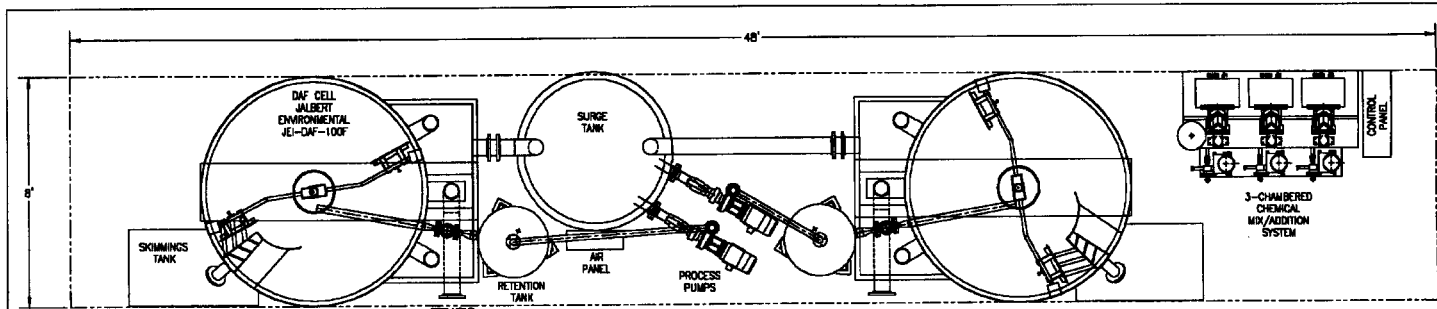

CONCEPTUAL 400 GPM (500 GPM MAX.)  
 FULL FLOW DAF SYSTEM  
 TWIN 200 GPM (250 GPM MAX. SEE NOTES) FULL  
 FLOW DAF WITH INTEGRAL CHEMICAL  
 MIX/FEED SYSTEM



JALBERT ENVIRONMENTAL INC.  
 (800) 476-3803 TEL. (767) 486-8448 FAX

- NOTES:
- 1) HYDRAULIC LOADING IS 1.99 GPM/SQ.FT. AT 200 GPM AND 2.48 GPM/SQ.FT. AT 250 GPM.
  - 2) DAF CELL HEIGHT IS APPROX. 8'-6" WITH HANDRAILS DETACHED. HEIGHT DOES NOT INCLUDE TRAILER DECK HEIGHT.
  - 3) BRIDGE AND HANDRAILS NOT SHOWN FOR CLARITY.
  - 4) TOTAL CLEAN/DRY AIR SUPPLY REQUIREMENTS ARE 4 SCFM AT 80 PSI.
  - 5) INLET AND EFFLUENT NOZZLE ORIENTATIONS ARE TYPICAL.
  - 6) TRAILERS, INFLUENT PUMPS, AND AIR SUPPLY NOT BY JALBERT ENVIRONMENTAL, INC.

JALBERT ENVIRONMENTAL, INC.					
ENVIRONMENTAL SERVICES					
REV	DATE	DESCRIPTION	BY	CHK'D	

UNIVERSITY  
 OF  
 MICHIGAN

NONE	PM	A
7/18/87		
TRAILER MOUNTED 400 GPM DAF SYSTEM FULL FLOW	7-2-083	
007018	0	



# HYDRO-FLO

**TECHNOLOGIES, INC.**

The Art & Science Of Wastewater Treatment

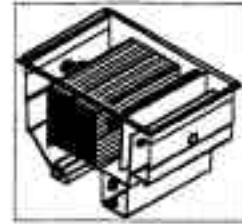

## REFERENCE:

SKID MOUNTED, SELF CONTAINED OILY & METALS WASTEWATER TREATMENT SYSTEM - 100 GPM

## DATE:

Tuesday, August 05, 1997

## TO:

Mr. Al Horjimon  
University of Michigan Transportation Research Institute  
2901 Baxter Rd.  
Ann Arbor, MI 48109-2150  
Tel: 313-764-5308 Fax: 313-936-1081

Dear Al,

Thank you for considering Hydro-Flo Technologies. Thought you would like a copy of our proposal that led to the building of the system that we supplied to the Navy at Puget Sound Naval Shipyard. This is a highly successful application of a totally self contained, fully portable package treatment system. The Navy contract included startup, proveout, and operator training.

I am pleased to propose the following equipment:

### (1) Model OILY WASTEWATER TREATMENT SYSTEM WITH METALS REMOVAL AND SLUDGE DEWATERING

#### SYSTEM CONFIGURATION DETAILS

- 100 GPM continuous and fully automatic process capability with system process monitoring.
- 100 GPM influent pump, heavy duty air operated diaphragm with filter, regulator, control solenoid, and lubricator.
- 100 GPM effluent pump. Stainless steel centrifugal pump with TEFC motor.
- Fully contained specially constructed triple skid system with secondary containment drip trays and drainage/sump system with portable influent suction hose for skid draining, integral sumps (3) for collection of skid drippings. Also included are strategically placed operator safety steps to prevent operators from stepping on system components, wiring, and plumbing. The skid systems will have properly balanced lifting lug systems included with a single lifting spreader bar assembly.
- High capacity duplex strainer system with stainless steel easy clean strainer screens.
- Effluent flow monitor with magnetic type flow sensor designed for wastewater applications.
- A 100 GPM Oil/Water Separator designed according to American Petroleum Institute Publication 421 "Design of Oil/Water Separators". The Oil/Water Separator has automatic oil skimming and 59 gallon oil storage with oil level sensing and indication. This Oil/Water Separator contains 1512 square feet of coalescing surface area. Liquid level gauge with high level alarm.

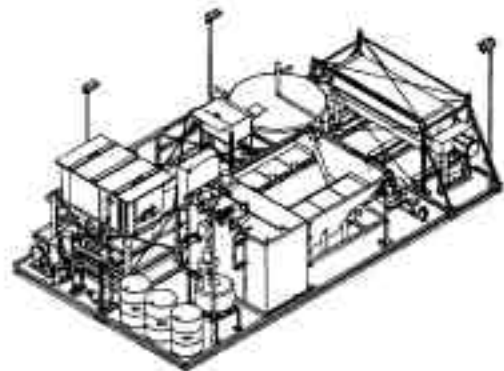

## **HYDRO-FLO TECHNOLOGIES, INC.**

---

- An automatic oil pump out system consisting of automatic oil level sensors installed in the oil/water separator oil reservoir, a 5 gpm bronze rotary gear oil pump with TEFC motor.
- A 100 GPM - 400 square foot inclined plate combination clarifier/flash/floc/pH adjusting system with integral chemical feed pumps and bearing supported gear driven 450 RPM mixers. The clarifier has a ribbon flight sludge auger for efficient and complete sludge evacuation. Liquid level gauge with high level alarm.
- Cationic polymer day tank with 30 gallon capacity, cone bottom, out of polymer low level sensor and automatic system shutdown.
- A 15 cubic foot filter press with, semi automatic closure, automatic pump/feed controller, air blowdown manifold, and filter cake dumpsters (2).
- A 1500 gallon sludge conditioning system including a sludge storage and mixing tank with high energy mixer, dry sludge variable output conditioner volumetric feeder, and automatic sludge filter press feed system.
- A startup supply of D.E. sludge conditioning material (enough to treat approximately 320,000 gallons of wastewater ).
- A startup supply of industrial wastewater treatment polymer chemicals, Anionic and Cationic polymers. (enough to treat approximately 320,000 gallons of wastewater ).
- A system washdown hose (50') with shutoff nozzle and hose storage rack.
- 4 - 1500 watt quartz halogen flood lights strategically placed for proper system illumination during night operations.
- Central control system NEMA 4X cabinet containing the 460 VAC to 110 VAC power transformer, the pH monitor/controller, the entire system component indication lights, pump controls, system function switches, alarm indications, flow meter readout, conductivity meter readout. All system indicators and controls are arranged in a flow diagram fashion to facilitate safe and easy understanding of system functions and indications. The controller shall be provided with lockout/tagout provisions, and safety power interlocks for service personnel safety.

Thank you again for considering Hydro-Flo Technologies. We look forward to the opportunity to provide you with the best wastewater treatment components and systems available. Please call if you have any questions, or would like to discuss other options or configurations.

Sincerely yours,

*Carey Krefft*

Sales Manager



**TECHNOLOGIES, INC.**

The Art & Science Of Wastewater Treatment

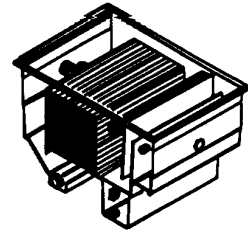

**CASE STUDY**  
**Oily Wastewater With Dissolved Metals**  
**Shipyards application**

**PROBLEM**

- **CATEGORY** (metals, oils, industrial, shipyard application)  
Oily wastewater with dissolved metals in a naval shipyard. This industrial application involved the treatment of barges of wastewater that are generated in the bilges of naval ships in port undergoing repairs..
- **GENERATION PROCESS** (ship repair and refitting) A wastewater barge is parked alongside the ship and the bilge water pumps are redirected to pump whatever bilge water is created into the barge. Repairs and other normal port operations are conducted that include machinery overhaul where oily sludges, diesel fuel, jet fuel, and dissolved metals are known to be present. Occasionally other exotic contaminants are introduced such as chromate metal preservatives, solvents, and fugitive pollutants of unknown origin. When the wastewater barge is full it is moved to a pier where it is pumped into shore side holding tanks of 15,000 gallons or more and await treatment.
- **FLOW RATE** As the barges full of wastewater are transferred to a holding tank the need to treat as it comes directly from the ship is eliminated. The flow rate for this project was 100 GPM. There were three other treatment systems already on site that are designed for 50 GPM each but are typically operated at between 30-50 GPM. The wastewater is treated by a dedicated system operator on 8 hour shifts for 48,000 gallons per shift. Typically one shift per day is adequate but occasionally two shifts a day are required to keep ahead of wastewater production depending on how many ships are in port at the time.
- **TREATMENT GOAL** (discharge to sewer). The treated wastewater is discharged to sanitary sewer under federal categorical pretreatment guidelines. This guideline was modified by local POTW authority to establish the following discharge criteria:

Oil & Grease <15mg/L  
Copper <0.05 mg/L  
Cadmium <0.05 mg/L  
Lead <0.1 mg/L  
Zinc <0.1 mg/L  
Nickel <0.1 mg/L  
Chromium <0.1 mg/L  
Silver <0.1 mg/L

**SOLUTION**

- **METHOD** (phase separation, sedimentation, sludge dewatering management) Free and dispersed oil needed to be recovered with an oil/water separator for possible recycling and to prevent gross oil from entering the downstream treatment system. Dissolved metal ions are precipitated as metal hydroxides and then destabilized and coagulated using a high charge cationic polymer. The resulting "pin floc" with a high percentage of metal precipitates and suspended solids is then flocculated using a high molecular weight long chain anionic polymer that gathers the pin floc into sizable, stable sludge particles with sufficient mass to settle properly in a lamella plate clarifier. The resulting sludge that contains metals and oily substance is drawn off the clarifier and conditioned with a high porosity filter aid material in preparation for dewatering. The conditioned sludge is then pumped into a filter press where it is dewatered to create a sludge cake of sufficient dryness to permit disposal in a landfill.

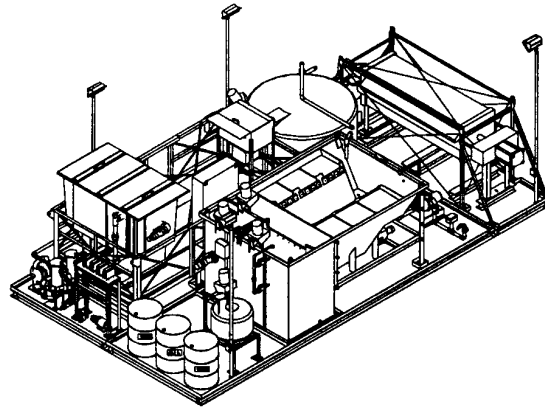

## **HYDRO-FLO TECHNOLOGIES, INC.**

---

- **CHEMISTRY (pH, flocculation)** pH is first measured and adjusted to 8.5 using caustic soda to create metal precipitates. If needed at this point the operator can elect to add a carbamate polymer that specializes in organometallic metals precipitation. This optional carbamate polymer is designed to precipitate chelated and otherwise complexed metals from the wastestream. A cationic polymer is then added to destabilize the molecular structure and allow "pin floc" to form and coagulate which will readily agglomerate and increase mass. The last chemical step in this process is a long chain anionic polymer designed to flocculate the precipitates and "pin flocs" into a large mass suitable for rapid settling in the non-hindered settling zone of a lamella clarifier. The resulting sludge having metals, TSS, and being oily in nature due to the presence of emulsified oils is conditioned with a filter aid material such as diatomaceous earth prior to dewatering in a filter press. This ensures proper cake formation and proper dryness of the finished cake material.
- **EQUIPMENT (oil/water separator, clarifier, filterpress)** The entire system was required to be skid mounted with 3' high full perimeter spill containment combing and the unit must be self contained except for the utilities, electricity, air and fresh water). There were size constraints limiting length, width, and height. The entire system could be no more than 11' high x 20' wide x 35' long. In addition, there were stringent crane lifting requirements and a 5:1 safety factor for the lifting padeye system.  
We designed a three skid system with all interconnecting plumbing made from flexible hoses and quick couplers and interconnecting wiring was achieved using multi-wire NEMA 4 quick connectors. The self contained skid(s), interconnecting plumbing, and wiring system made site setup and initial system startup very quick and easy. The entire system is easily set up by two people in less than two hours (not including lifting and trucking staff). The system consisted of the following major components:
  - 1.) **Hydro-Flo Technologies TotalSep** oil/water separator model T8035-P21, with integral sludge hopper chamber, fiberglass construction with PVC DynaPak coalescing media and automatic adjustable oil skimmer.
  - 2.) **Hydro-Flo Technologies CIPC-440** Combination FlashFloc/Inclined Plate Clarifier with an optional "Metal Trapper" flash chamber added for carbamate polymer addition. The carbamate polymer system is designed to remove complexed and chelated metals. The CIPC-440 has 440 square feet of settling surface area made of ultra smooth 60 degree inclined FRP corrugated plates. The CIPC-440 also included an optional integral fully automatic microprocessor based pH controller for caustic addition on demand. The sludge settling chamber includes the standard stainless steel, sludge bottom squee with converging flights to draw settled sludge to the outlet nozzle and prevent compacted sludge buildup.
  - 3.) **A JWI Filter Press**, A 15 cubic foot 800mm plate and frame unit with 2000 gallon sludge feed conditioning tank that included an automatic variable output volumetric feeder for addition of dry filter aid material (DE). Also included were the sludge filter cake forkliftable dumpsters for easy dry cake handling, sludge feed slurry pump, filtrate discharge pump and filtrate transfer tank.
  - 4.) **General Componentry**: In addition to the major components listed above there was also an influent pump; an effluent pump; an 80 gallon anionic polymer day tank with mixer; a bank of adjustable chemical feed pumps; low chemical sensing system, an effluent pump; a highly automated and easy to operate central system control package; OSHA safety lockout tagout system and system interlocks including loss of power, and high water level sensing in several locations. The entire system was designed and built with operator safety, and simplicity in mind. Typical "maintenance required" components were thoughtfully located and installed to provide easy access. Placarding indicating safety concerns such as voltage, pressure, corrosiveness and operating danger and tripping hazards were properly installed. Operator access areas were provided with non-skid decking plates or coatings to ensure safety.

## **HYDRO-FLO TECHNOLOGIES, INC.**

---

- **AUTOMATION LEVEL** (fully automated operation). The entire system is operable by a single person. As there are actually two systems in one, wastewater treatment and sludge handling, there was a need for a high level of functional automation. Systems are monitored for status, tank levels are monitored to prevent spillage, chemicals are monitored for adequate supply, and pumps are cycling in automatic mode. This level of logic manipulation required the use of a PLC (Programmable logic controller). By using a PLC we are able to reduce the overall cost of the controls package by reducing the number of relays needed, by reducing the size of the main control cabinet, and by simplifying the building of the control circuit. The added advantage of using a PLC is the ease in which modification of the logic of the program can occur to accommodate changes in functional operation. Slight modifications of the PLC program were done during initial startup to accommodate unforeseen site conditions. The loss of air power safety interlock, and effluent valve operation were easily changed, changes that would have been quite difficult with ordinary electromechanical relay design. The entire controls package was designed, built, and programmed by Hydro-Flo Technologies engineering and technical staff.

The main control panel was supplied with the following operator interface features:

- a.) A large laminated "process diagram" that included status indicator lights on all major system components and a color coded system plumbing diagram.
- b.) A two line 32 x 20 character LED display for system fault annunciation.
- c.) pH, effluent flow rate and totalizer, and effluent conductivity meters with digital readouts.
- d.) Audible alarm horn.
- e.) All major component function switches with manual override.

### **INVOLVEMENT**

- **DESIGN** Hydro-Flo Technologies has extensive engineering and production capabilities with design, fabrication, and final integration performed in our facility in Carol Stream IL, a suburb of Chicago. Our expert engineering staff works with state of the art AutoCAD 13 in a true 3D platform producing superb arrangement and fabrication drawings. Our electrical and structural engineers complete the package for highly professional results.
- **SPECIFICATIONS** The customer specifications submitted were almost entirely performance based with no bias for methodology. There were basic specifications for certain mechanical requirements many of which were addressed above. The methodology, arrangements, sizing, and component selections were left to the supplier (Hydro-Flo Technologies).
- **INSTALLATION** As the system was supplied as a skid mounted self contained package the installation consisted of lifting the three skids from the truck, placing them in appropriate orientation, hooking up the interconnecting plumbing and wiring and making utility connections (electricity, air, water, effluent and influent). The client supplied the lifting, and utilities work, and Hydro-Flo Technologies performed the skid interconnecting work. The entire system was ready to operate for the first time in less than 4 hours.
- **STARTUP & TRAINING** Hydro-Flo Technologies was contracted to provide initial startup, calibration, and training. Performance verification was completed during startup with chemical analysis being performed with the clients selected lab. All performance parameters were met on the first testing cycle leading to a rapid conclusion of other contract requirements and enabling the system users to begin continuous processing of the wastewater. Complete and extensive operators manuals were provided that included a collection of descriptive 3D diagrams that made hookup, and component identification easy. Training was provided by Hydro-Flo Technologies and included a comprehensive training booklet for each attendee. The training was conducted over a three day period and included classroom period that covered system methodology, basic applied chemistry, system maintenance and operation. The balance of the training was concluded as a hands on session that included all phases of operation from hookup, to sludge processing, to chemical replenishment, to calibration, to troubleshooting, to shutdown.

## Skid Mounted Self Contained Metals & Oily Wastewater Treatment System - General Layout

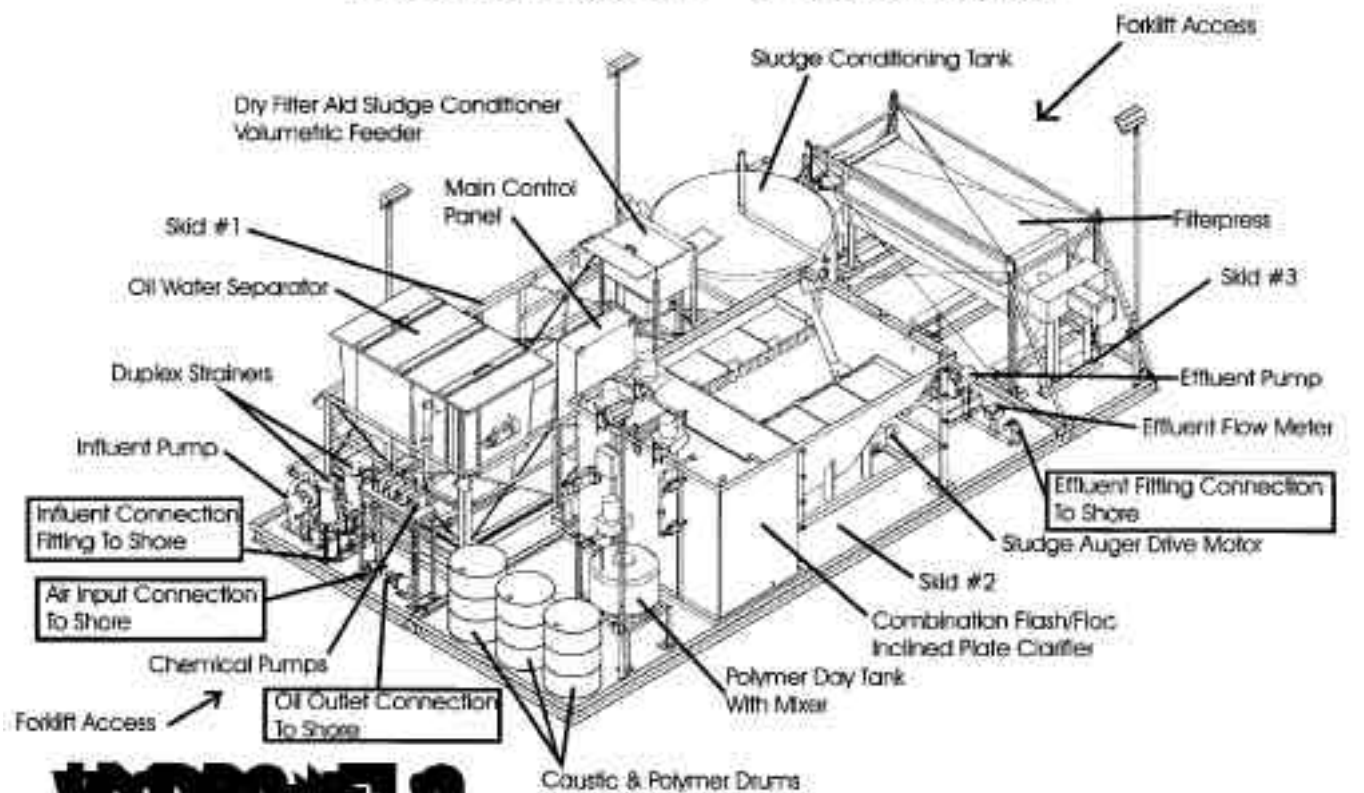

**HYDRO-FLO**  
 TECHNOLOGIES, INC.  
 The Art & Science Of Wastewater Treatment

Boxed Text Indicates  
 Connection Points

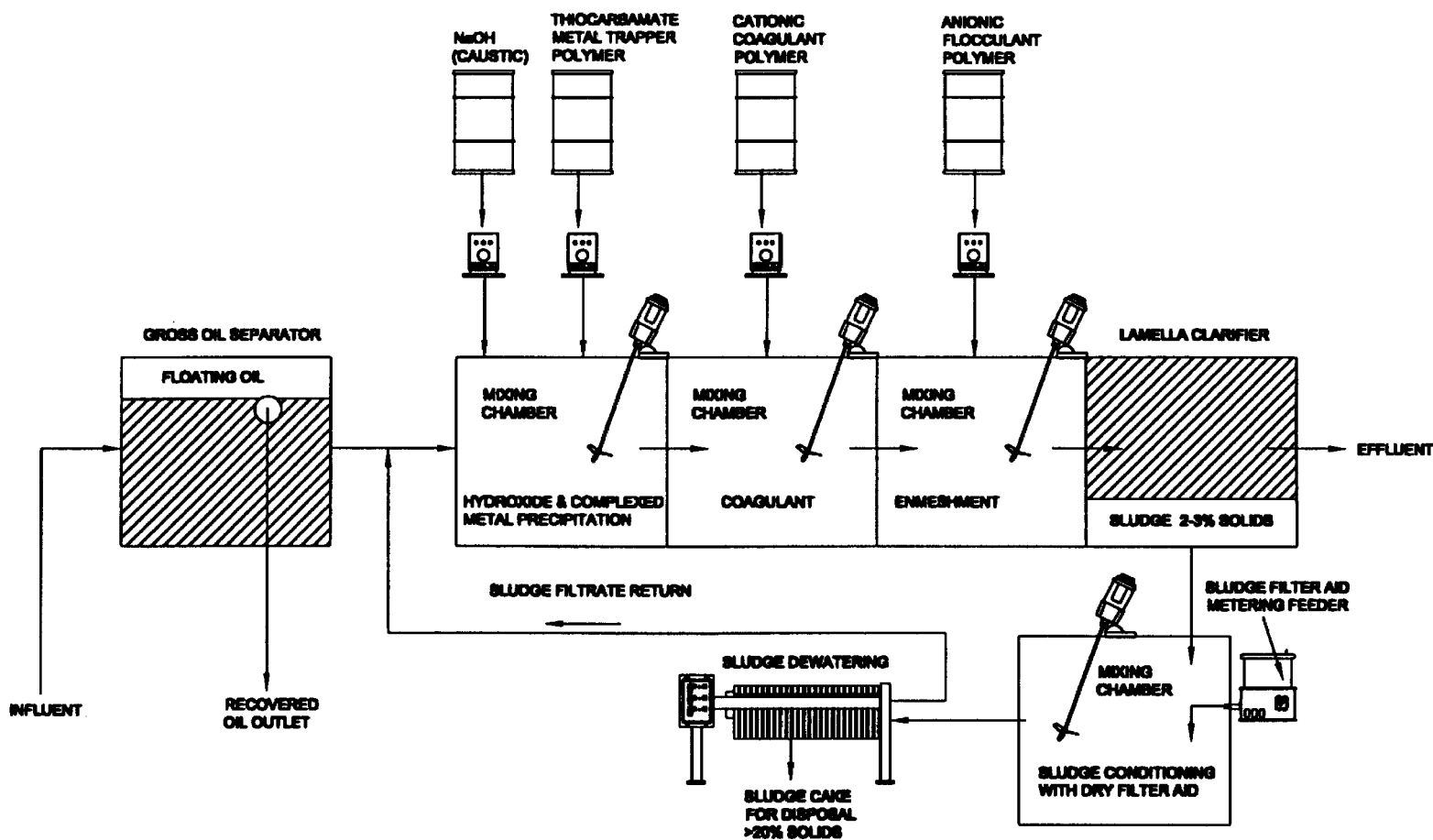

**COMPLEX WASTEWATER TREATMENT AND SLUDGE DEWATERING PROCESS  
FREE AND EMULSIFIED OILS RECOVERY- CHELATED & SOLUBLE METALS REMOVAL**

**HYDROFLO TECHNOLOGIES INC.**  
 205 East Kehoe Boulevard-Suite 2, Carol Stream, IL 60188

THIS DRAWING IS THE PROPERTY OF HYDRO-FLO TECHNOLOGIES, INC. AND IS TO REMAIN UNLESS THE EXPRESS CONSENT IS GIVEN. IT SHALL NOT BE COPIED OR REPRODUCED IN ANY MANNER, THAT IT SHALL NOT BE SUBMITTED TO OTHERS FOR CONSIDERATION WITHOUT THE CONSENT OF THIS COMPANY. THAT IT SHALL NOT BE USED IN ANY OTHER WAY DETRIMENTAL TO THE INTERESTS OF THIS COMPANY AND THAT IT SHALL BE RETURNED UPON DEMAND.

**COMPLEX WASTEWATER TREATMENT PROCESS  
OIL RECOVERY / SOLUBLE METALS REMOVAL  
SLUDGE CONDITIONING & DEWATERING**

TOLERANCES UNLESS NOTED: ±3/16"		SCALE: X - X	DRAWN: CAK	DATE: 11/26/97
JOB: X		CUSTOMER: CONCEPT	APPRVD: X	DATE: X
REV: DATE		CHANGES	DRAWING NUMBER: CONCEPT	SHT NO: X OF X

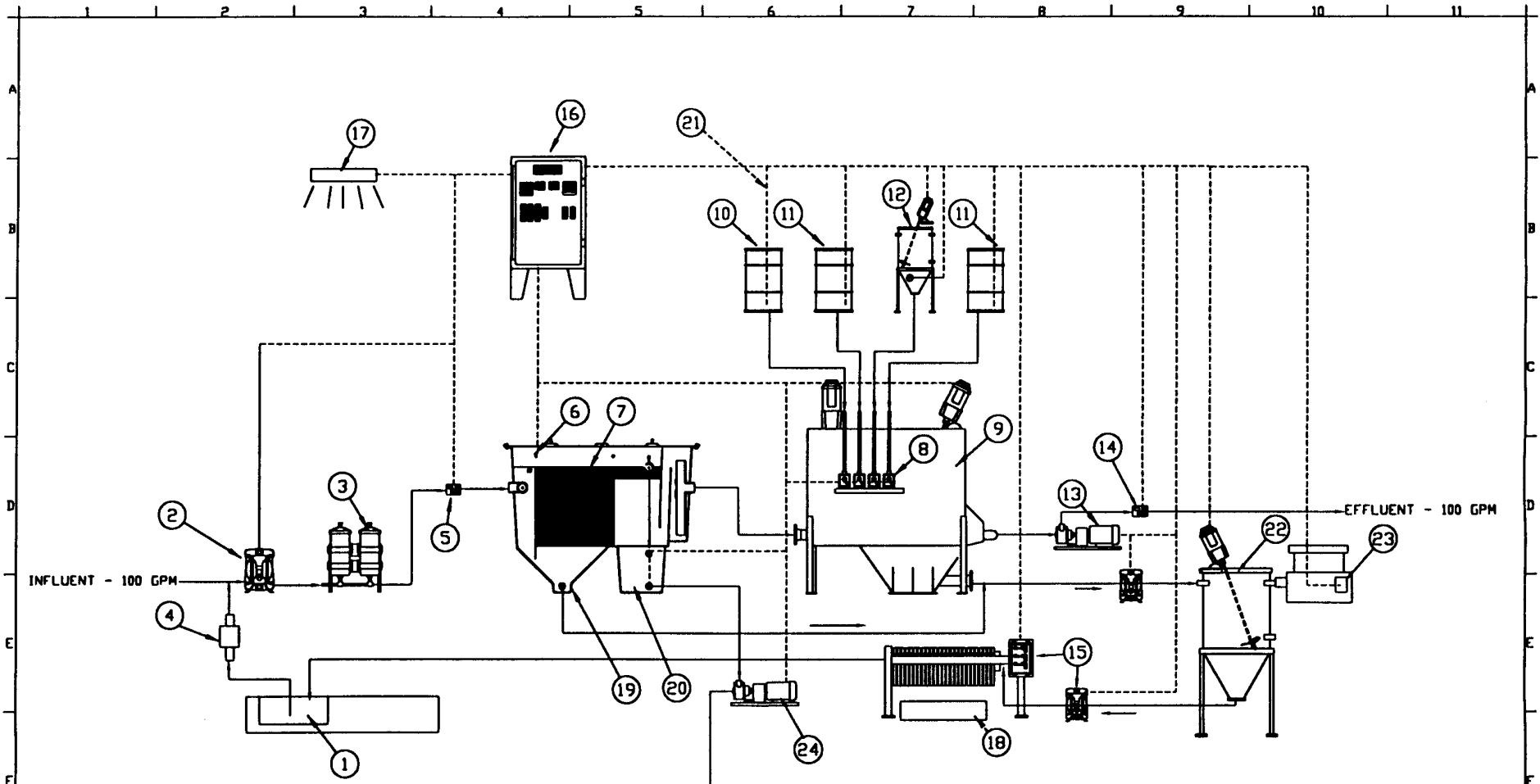

- 1 SKIDS (2) WITH DRIP PAN AND PLUMBING
- 2 INFLUENT PUMP, AIR OPERATED
- 3 DUPLEX STRAINER
- 4 SUMP SUCTION CONTROL VALVE
- 5 INFLUENT FLOW METER
- 6 LEVEL SENSOR
- 7 OIL WATER SEPARATOR
- 8 CHEMICAL FEED PUMPS (1-NAOH & 3-POLYMER)
- 9 CLARIFIER, 440 FT<sup>2</sup>, WITH SLUDGE AUGER
- 10 CAUSTIC TANK (BY OTHERS, 55 GALLON DRUM)
- 11 POLYMER DAY TANK (CATIONIC - CARBAMATE)
- 12 POLYMER DAY TANK WITH MIXER (ANIONIC)
- 13 EFFLUENT PUMP, ELECTRIC CENTRIFUGAL
- 14 EFFLUENT CONDUCTIVITY METER
- 15 SLUDGE FILTER PRESS WITH FEED PUMP (AIR)
- 16 MAIN CONTROL PANEL-pH/FLOW/COND METERS
- 17 HALOGEN LIGHTS (4)
- 18 FILTER CAKE DUMPSTER
- 19 SLUDGE CHAMBER & OUTLET
- 20 RECOVERED OIL CHAMBER & LEVEL SENSORS
- 21 POLYMER FEED TANKS LOW LEVEL SENSORS
- 22 SLUDGE CONDITIONER TANK
- 23 DRY SLUDGE CONDITIONER VOLUME FEEDER
- 24 AUTOMATIC OIL TRANSFER PUMP

AUTOMATIC OIL PUMPOUT

----- INSTRUMENTATION & CONTROLS

————— PROCESS FLOWS

MAXIMUM SYSTEM OVERALL DIMENSIONS: 35' LONG X 18' WIDE X 8'6" TALL

1	9-25-94	PROCESS
REV	DATE	CHANGES

**HYDRO-FLO** TECHNOLOGIES INC.  
 205 East Kehoe Boulevard-Suite 2, Carol Stream, IL. 60188

THIS DRAWING IS THE PROPERTY OF HYDRO-FLO TECHNOLOGIES, INC. AND IS LOANED UPON THE EXPRESS CONDITION THAT IT SHALL NOT BE COPIED OR REPRODUCED IN ANY MANNER, THAT IT SHALL NOT BE SUBMITTED TO OTHERS FOR COMMENT OR WITHOUT THE CONSENT OF THIS COMPANY, THAT IT SHALL NOT BE USED IN ANY OTHER WAY DETRIMENTAL TO THE INTERESTS OF THIS COMPANY AND THAT IT SHALL BE RETURNED UPON DEMAND.

**OILY WASTE TREATMENT SYSTEM (P&ID)**  
 INCLUDES METALS REMOVAL AND SLUDGE PROCESS  
 100 GPM - 400 SQUARE FOOT CLARIFIER

TOLERANCES UNLESS NOTED: ±3/16"		SCALE: X - X	DRAWN: CAK	DATE: 9-5-95
JOB		CUSTOMER	APPRVD: X	DATE: X
PROP		USN - BREMERTON	DRAWING NUMBER	SHT NO:
			9609-05-01	1 OF 1



## **APPENDIX E**

### **COMPANIES SUPPLYING INFORMATION**

## Appendix E

### Companies Supplying Information

Apollo Engineering  
2000 Dairy Ashford, Suite 460  
Houston, TX 77077  
713-496-5999

Blohm & Voss  
via Simplex-Turmar, Inc.  
PO Box 168  
Little Neck, NY 11368-0168  
718-460-1220

Clean Harbors Inc  
Environmental Engineering Co.  
325 Wood Road  
Braintree, MA 02184  
617-849-1200

Great Lakes Environmental  
463 Vista  
Addison, IL 60101-4442  
708-543-9444

Filtration/Treatment Systems, Ltd.  
Advanced Environmental Solutions, Inc.  
7118 South 220<sup>th</sup> Street  
Kent, Washington 98032  
253-872-9007

Highland Tank & Manufacturing Co.  
One Highland Road  
Stoystown, PA 15563  
814-893-5701

Hyde Products, Inc.  
28045 Ranney Pkwy  
Westlake, OH 44145-1188  
440-871-4885

Hydro-Flo Technologies  
205 East Kehoe, Unit 2  
Carol Stream, IL 60188  
630-462-7550

Jalbert Environmental, Inc  
2848 Crusader Circle  
Virginia Beach, VA 23456  
757-468-2747

J D Meagher, Inc.  
57 E Main St,  
Westborough, MA 01581-1464  
508-366-6606

Microphor, In.  
452 East Hill rd  
PO Box 1460  
Willits, CA 95490  
707-459-5563

Monarch Separators  
5410 Trafalgar Dr.  
PO Box 450287  
Houston, TX 77045  
713-433-7441

Separation Dynamics, Inc.  
23801 Industrial Park Dr.  
Studio Center  
Farmington Hills, MI 48335  
810-478-7910

Additional copies of this report can be obtained from the  
National Shipbuilding Research and Documentation Center:

**<http://www.nsnet.com/docctr/>**

Documentation Center  
The University of Michigan  
Transportation Research Institute  
Marine Systems Division  
2901 Baxter Road  
Ann Arbor, MI 48109-2150

Phone: 734-763-2465  
Fax: 734-763-4862  
E-mail: [Doc.Center@umich.edu](mailto:Doc.Center@umich.edu)